

# Replication, Transcription and Translation

# Central Dogma

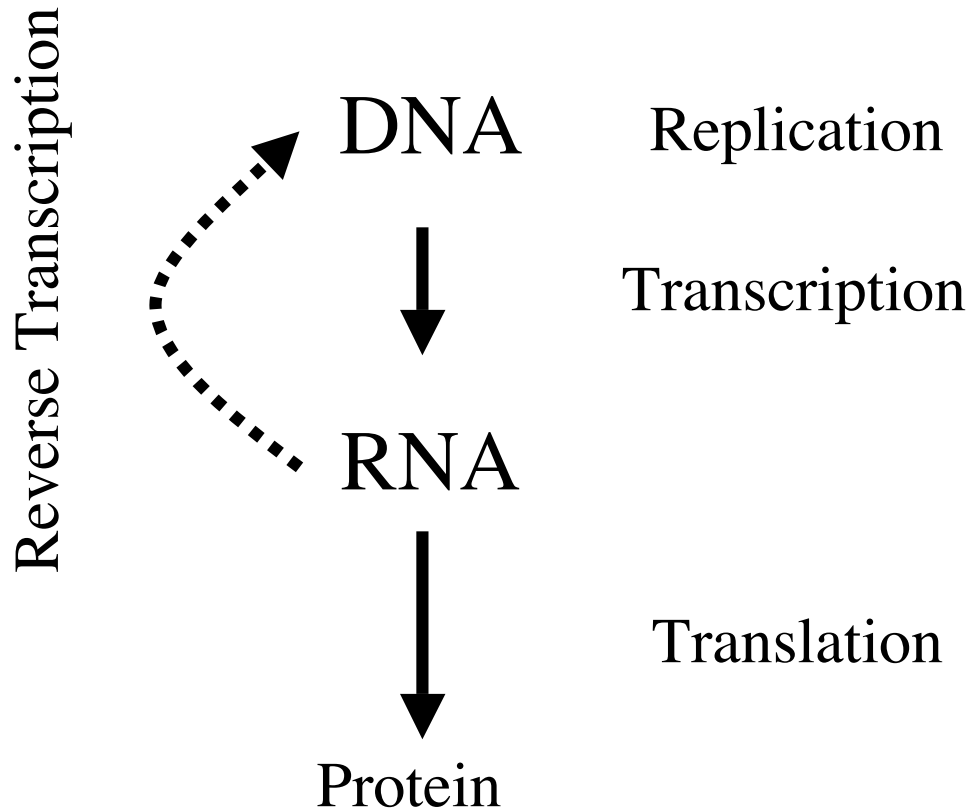

Images removed due to copyright restrictions.

# Flow of information

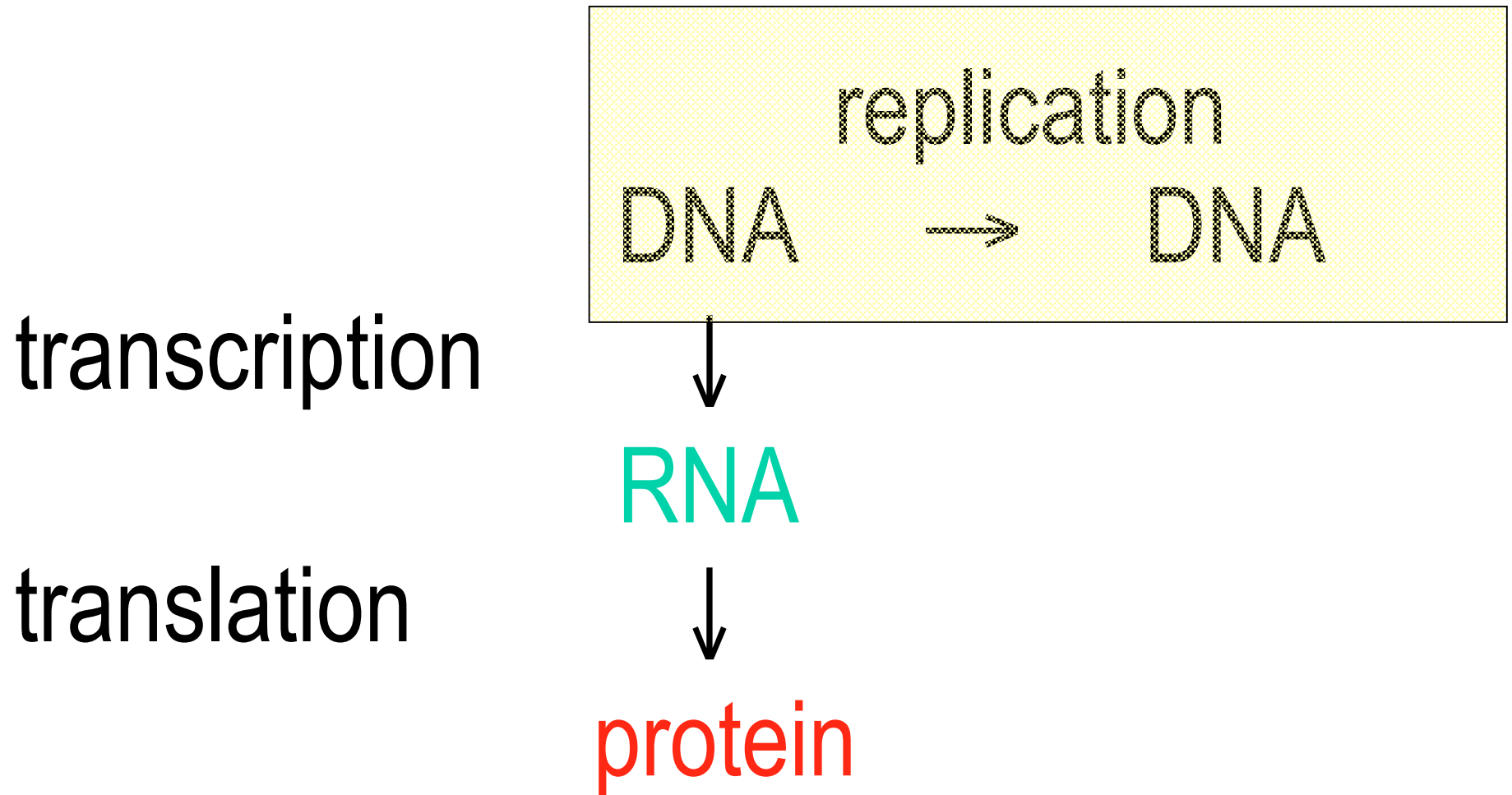

5' end

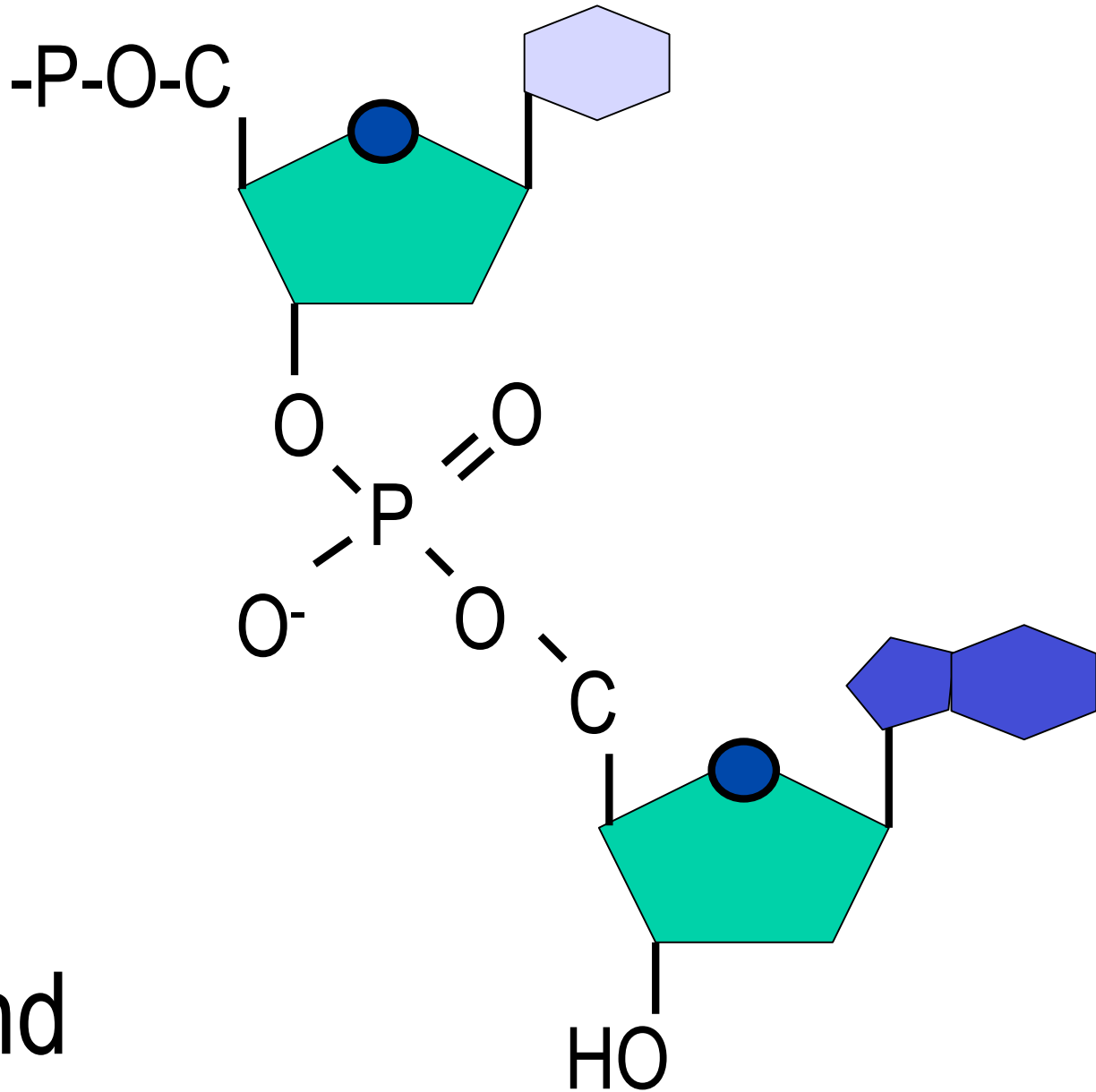

3' end

ring numbering  
system for  
deoxyribose

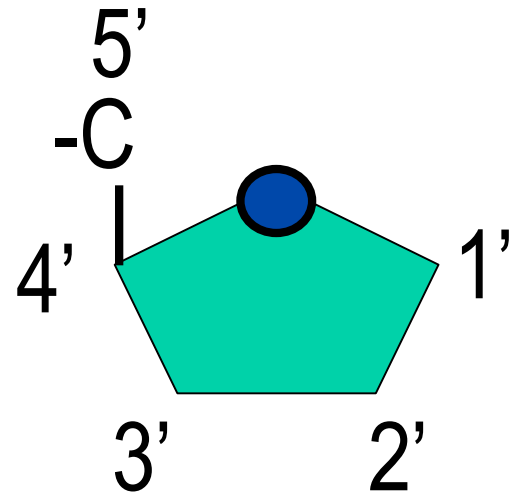

ssDNA

In a **nucleotide**, e.g., adenosine monophosphate (AMP), the base is bonded to a ribose sugar, which has a phosphate in ester linkage to the 5' hydroxyl.

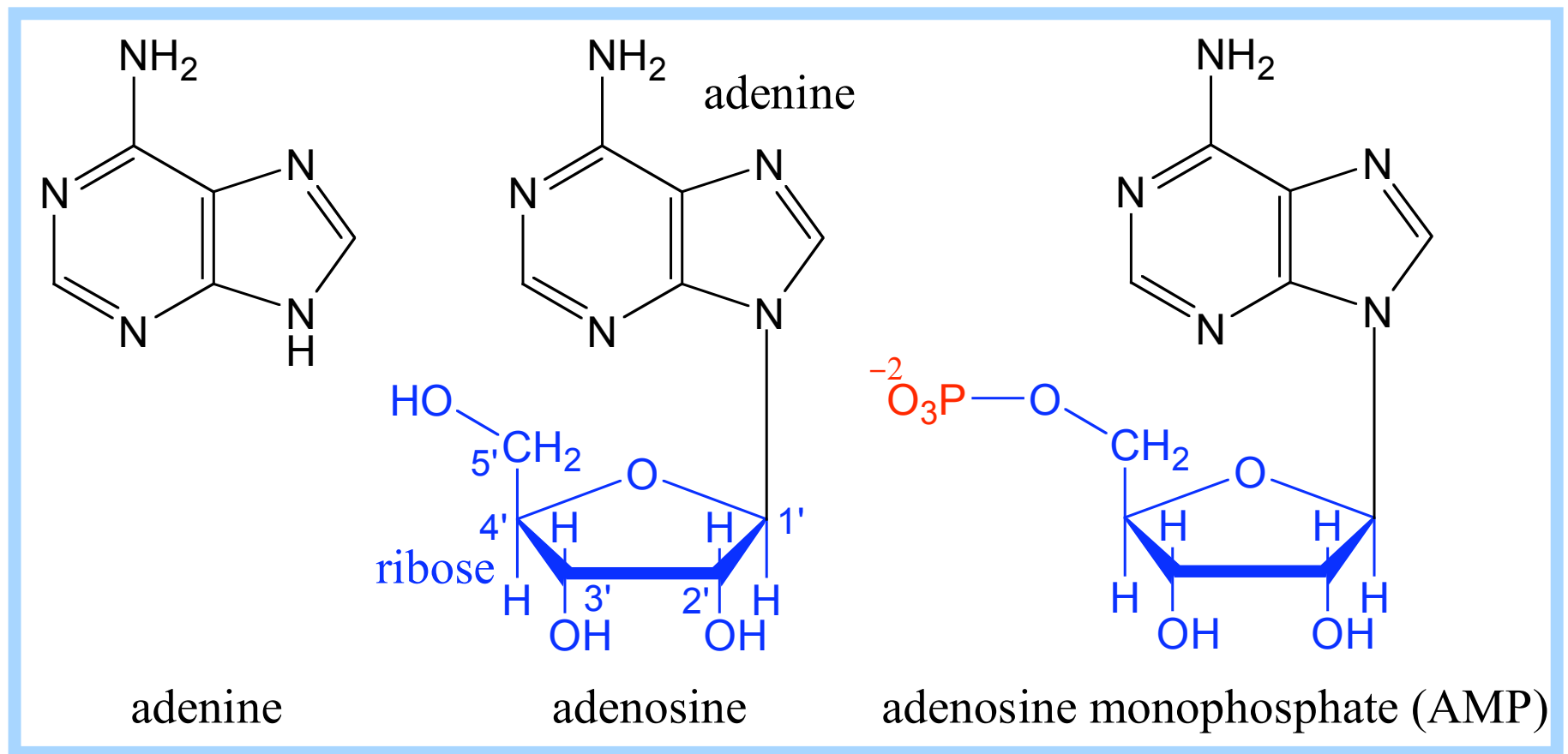

**Nucleic acids** have a backbone of alternating  $P_i$  & ribose moieties.

### **Phosphodiester**

linkages form as the 5' phosphate of one nucleotide forms an ester link with the 3' OH of the adjacent nucleotide.

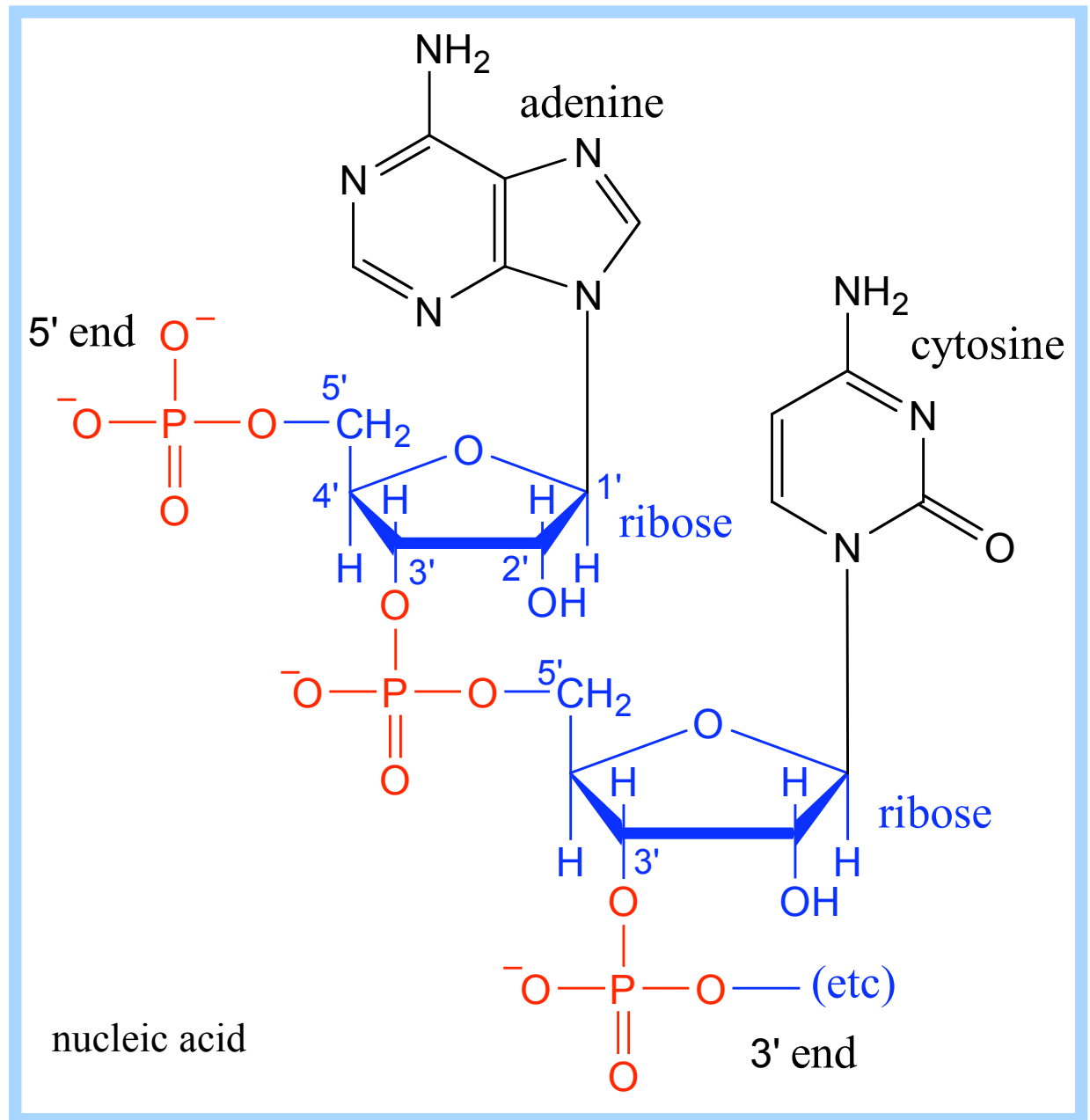

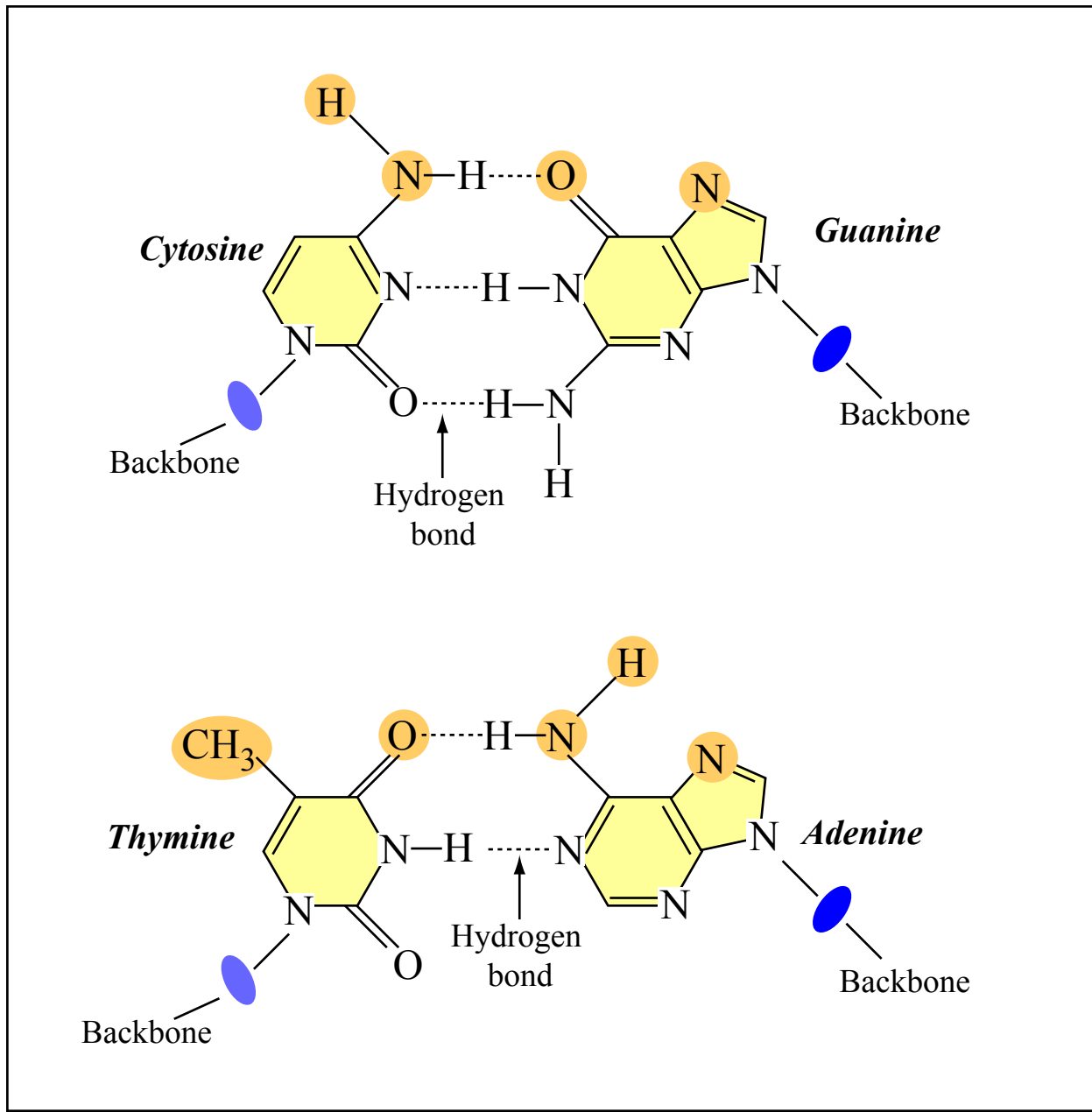

Figure by MIT OCW.

Diagram of genetic structure removed due to copyright restrictions.

See Figure 7-4 in Madigan, Michael, and John Martinko. *Brock Biology of Microorganisms*. 11th ed. Upper Saddle River, NJ: Pearson Prentice Hall, 2006. ISBN: 0131443291.



# Replication

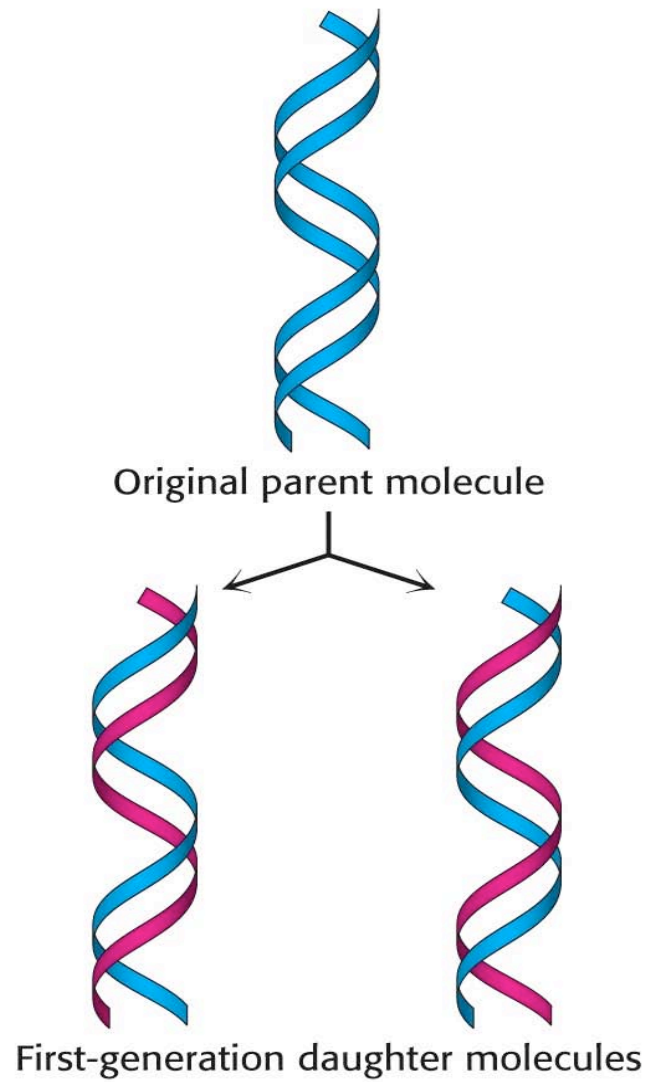

# DNA Replication

- A fundamental process
- Experimentally demonstrated

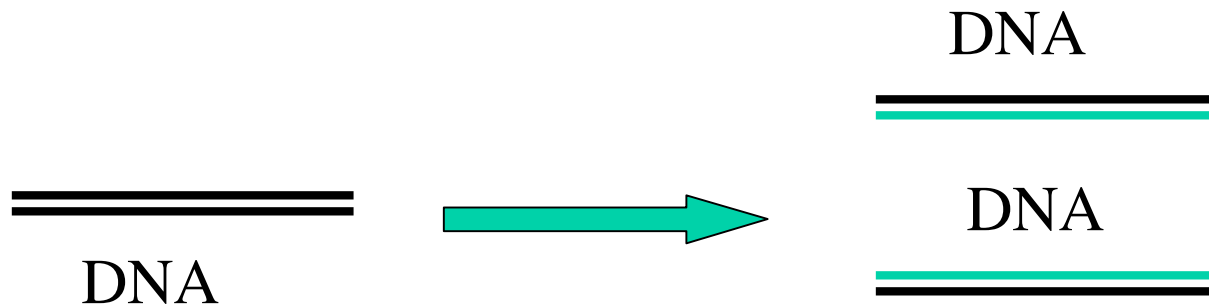

## DNA Replication

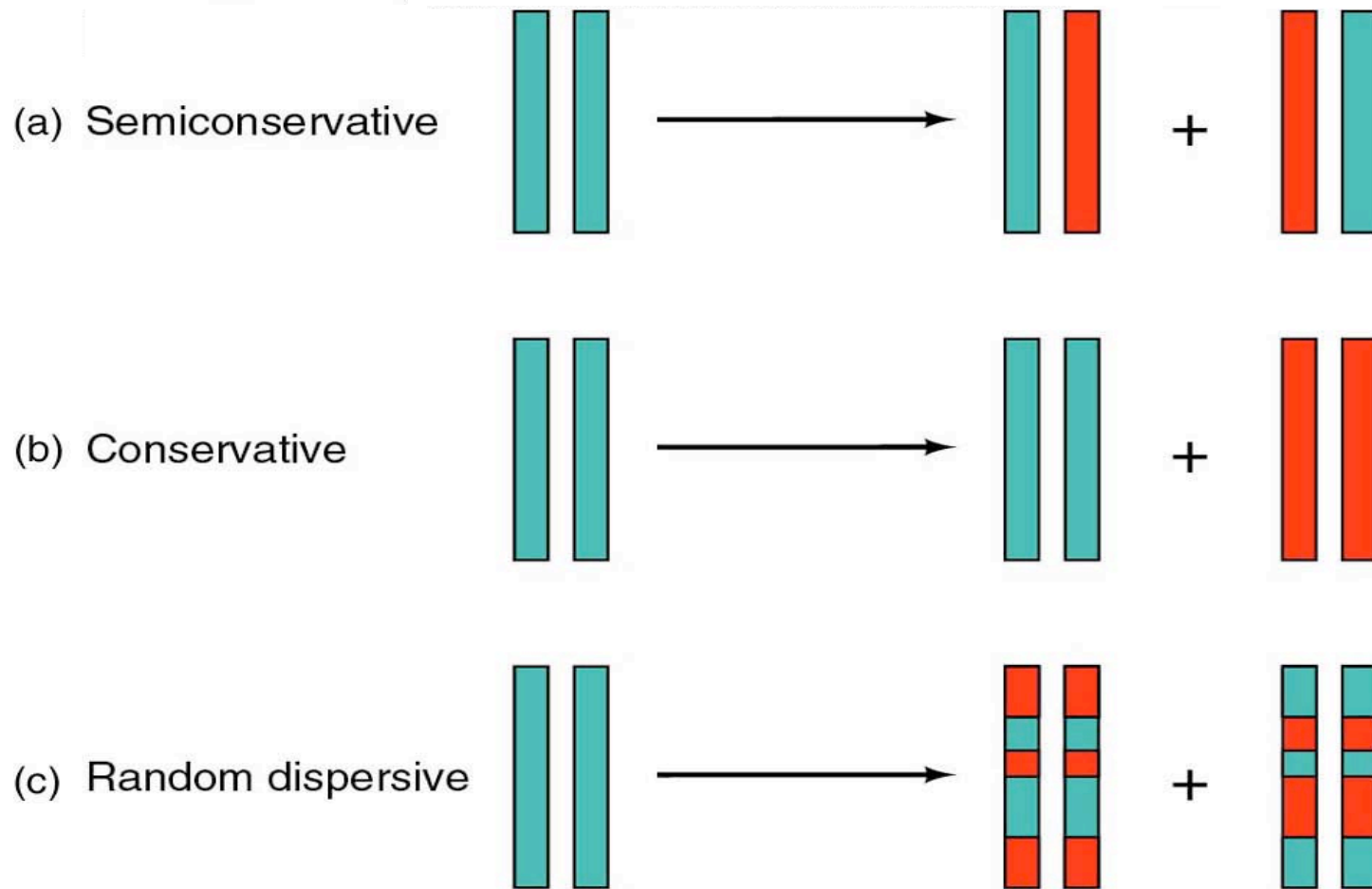

## THREE HYPOTHESES FOR DNA REPLICATION

## Stable isotopes in biology

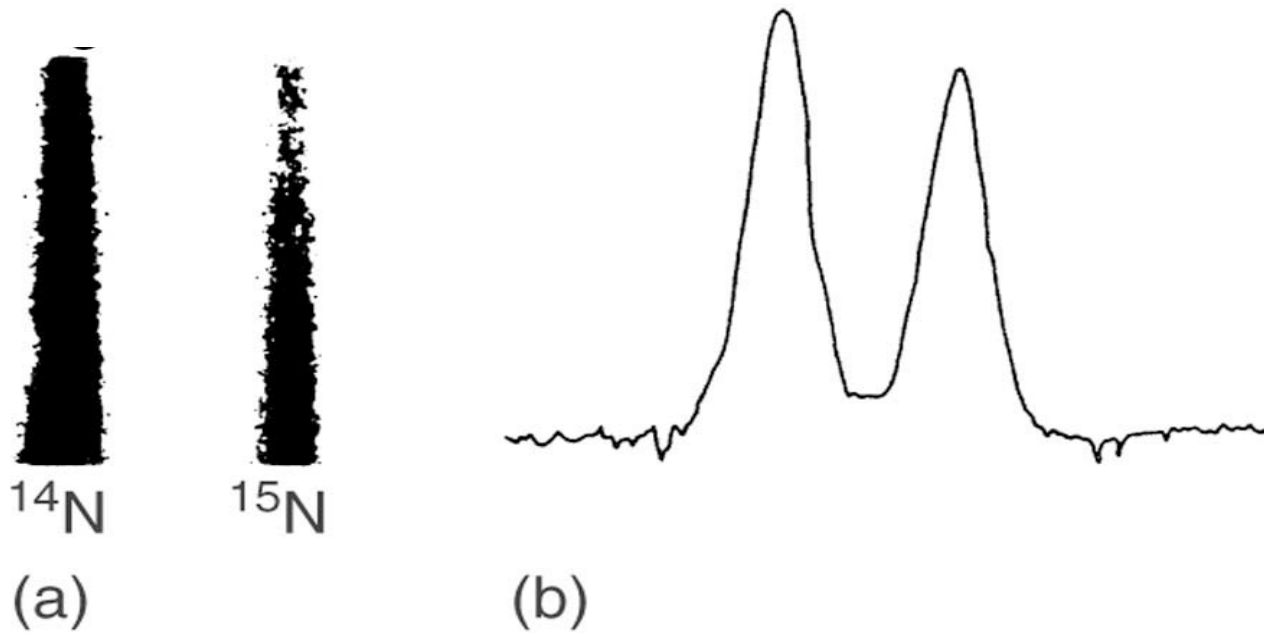

### SEPARATION OF DNAs BY CESIUM CHLORIDE DENSITY GRADIENT CENTRIFUGATION

- (a) Photo of DNA in ultracentrifuge rotor made with UV light
- (b) Densitometric trace of UV scan

$^{15}\text{N}$  labeled

$^{14}\text{N}$  labeled

1. Grow E coli so DNA uniformly  $^{15}\text{N}$  labeled

2. Add  $^{14}\text{N}$  labeled to growth media and observe result over several generations of growth

## PREDICTED DENSITIES OF NEWLY REPLICATED DNA MOLECULES ACCORDING TO THE THREE HYPOTHESES ABOUT DNA REPLICATION

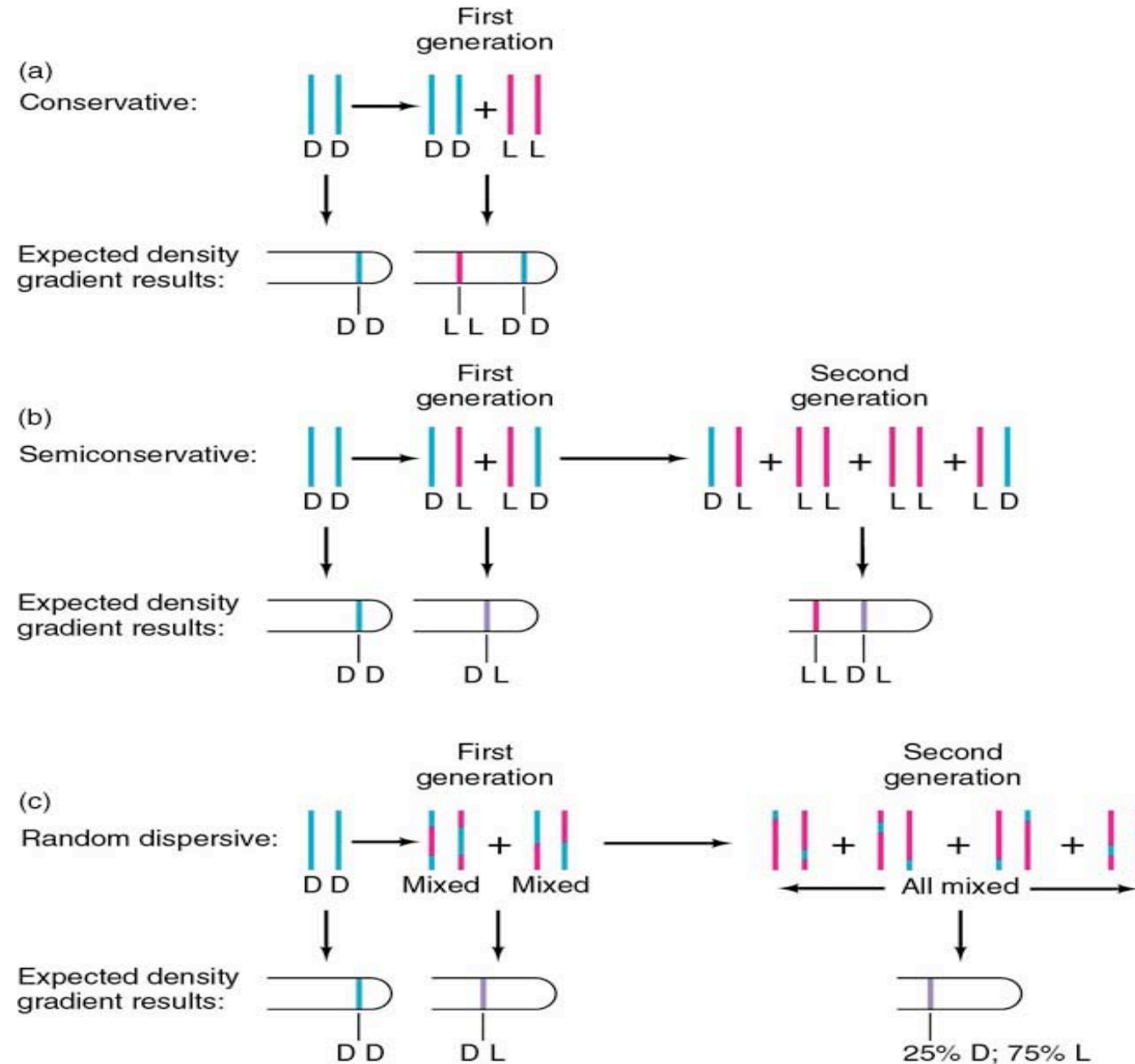

Image of experimental results removed due to copyright restrictions.  
See Meselson, and Stahl. "The Replication of DNA in Escherichia coli."  
*PNAS* 44 (1958): 674, f. 4.

**RESULTS OF CsCl GRADIENT  
ULTRACENTRIFUGATION  
EXPERIMENT SHOWING  
DISTRIBUTION OF DNA  
DENSITY IN *E. coli* CELLS  
AFTER 0 TO 4.1  
GENERATIONS OF GROWTH**

**THIS EXPERIMENT ESTABLISHED  
THAT DNA REPLICATION IS  
SEMICONSERVATIVE**

# Conclusion

## 1. DNA replication is semi-conservative

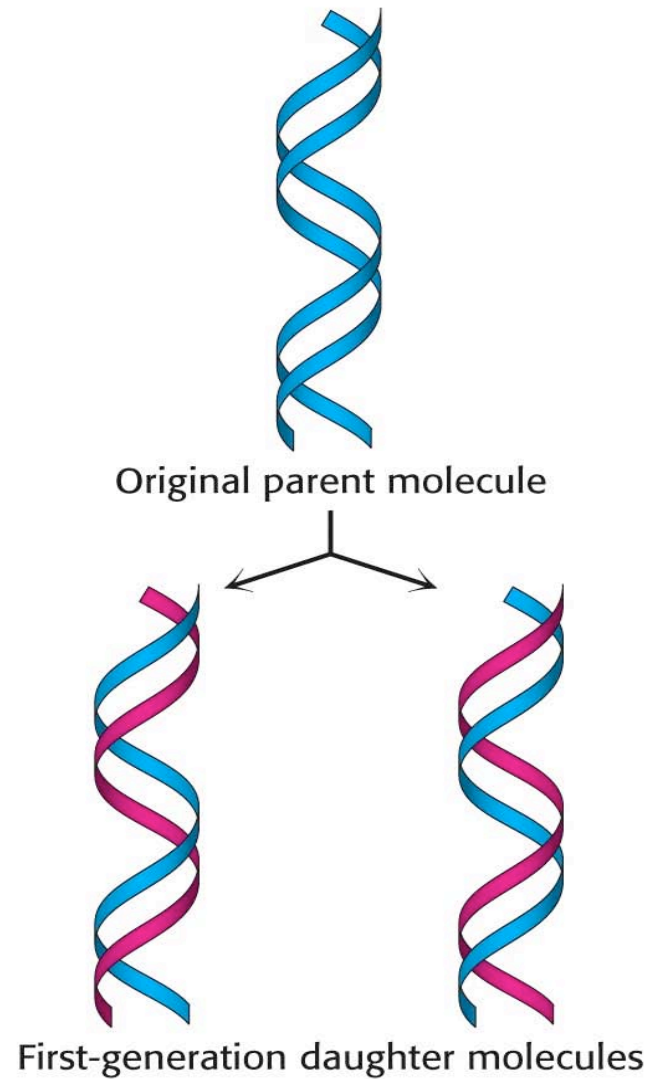

# DNA Replication Process

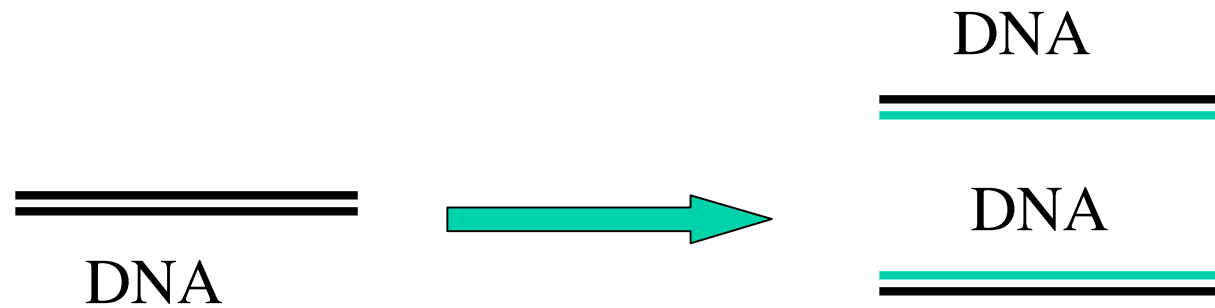
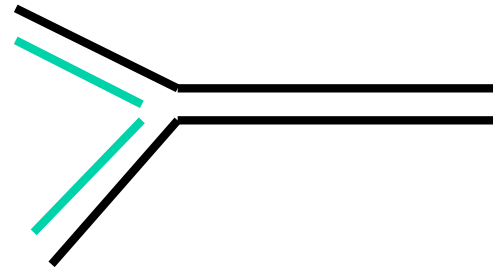

Diagram removed due to copyright restrictions.

See Figure 7-12 in Madigan, Michael, and John Martinko. *Brock Biology of Microorganisms*. 11th ed. Upper Saddle River, NJ: Pearson Prentice Hall, 2006. ISBN: 0131443291.





All DNA polymerases require a primer  
DNA is synthesized 5' to 3'

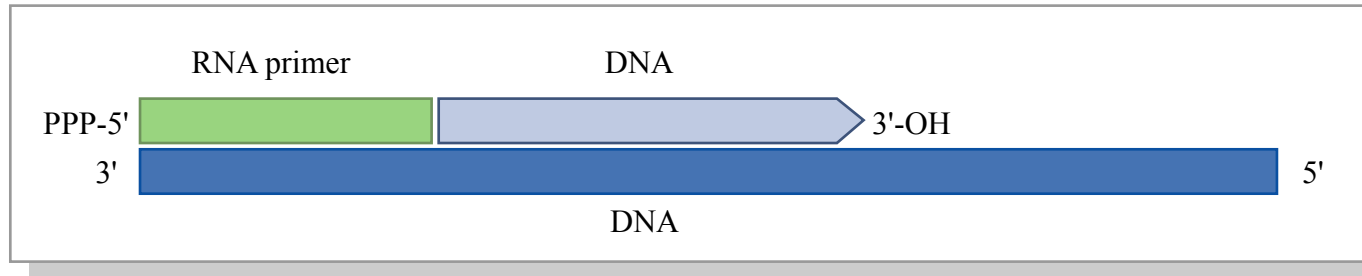
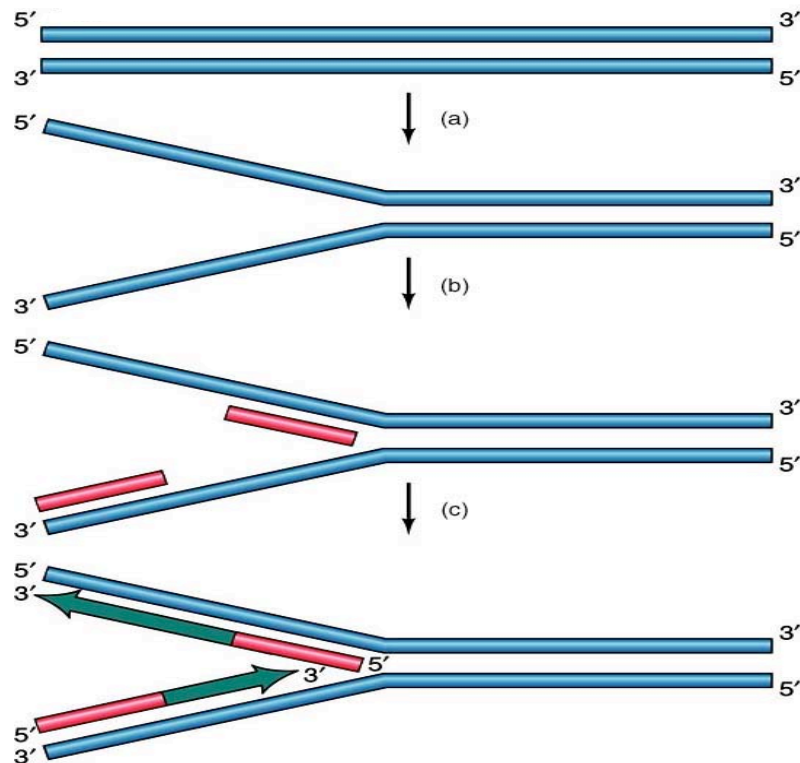

Figure by MIT OCW.



**PRIMING OF DNA SYNTHESIS BY  
SHORT SEQUENCES OF RNA (RED)**

**DNA POLYMERASE USES THE  
PRIMERS AS STARTING POINTS  
TO SYNTHESIZE PROGENY  
DNA STRANDS (GREEN ARROWS)**

Table of the major enzymes involved in DNA replication in bacteria removed due to copyright restrictions.  
See Table 7-3 in Madigan, Michael, and John Martinko. *Brock Biology of Microorganisms*.  
11th ed. Upper Saddle River, NJ: Pearson Prentice Hall, 2006. ISBN: 0131443291.

# Helicase & topoisomerase

Unwind & remove supercoils in duplex DNA

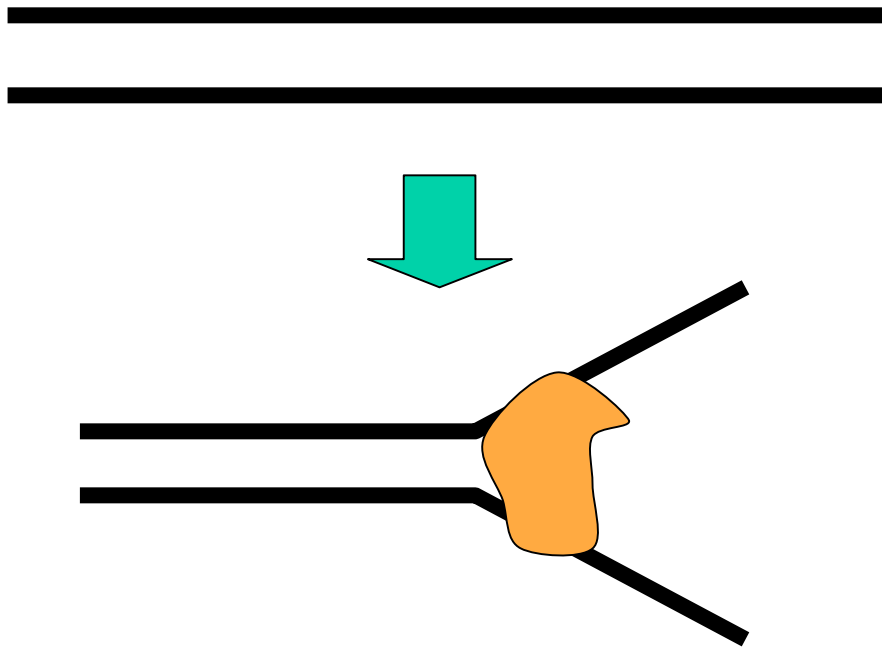

ssDNA binding protein

binds to and stabilizes ssDNA

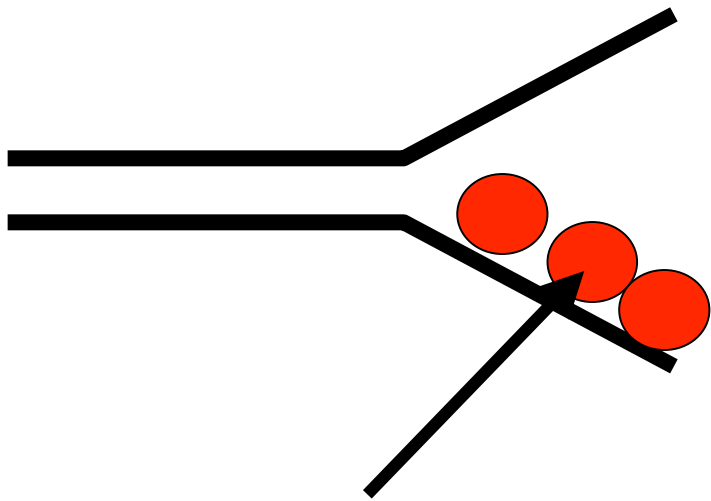

prevents base pairing

ssDNA binding protein

primase

synthesizes a short RNA primer  
using a DNA template

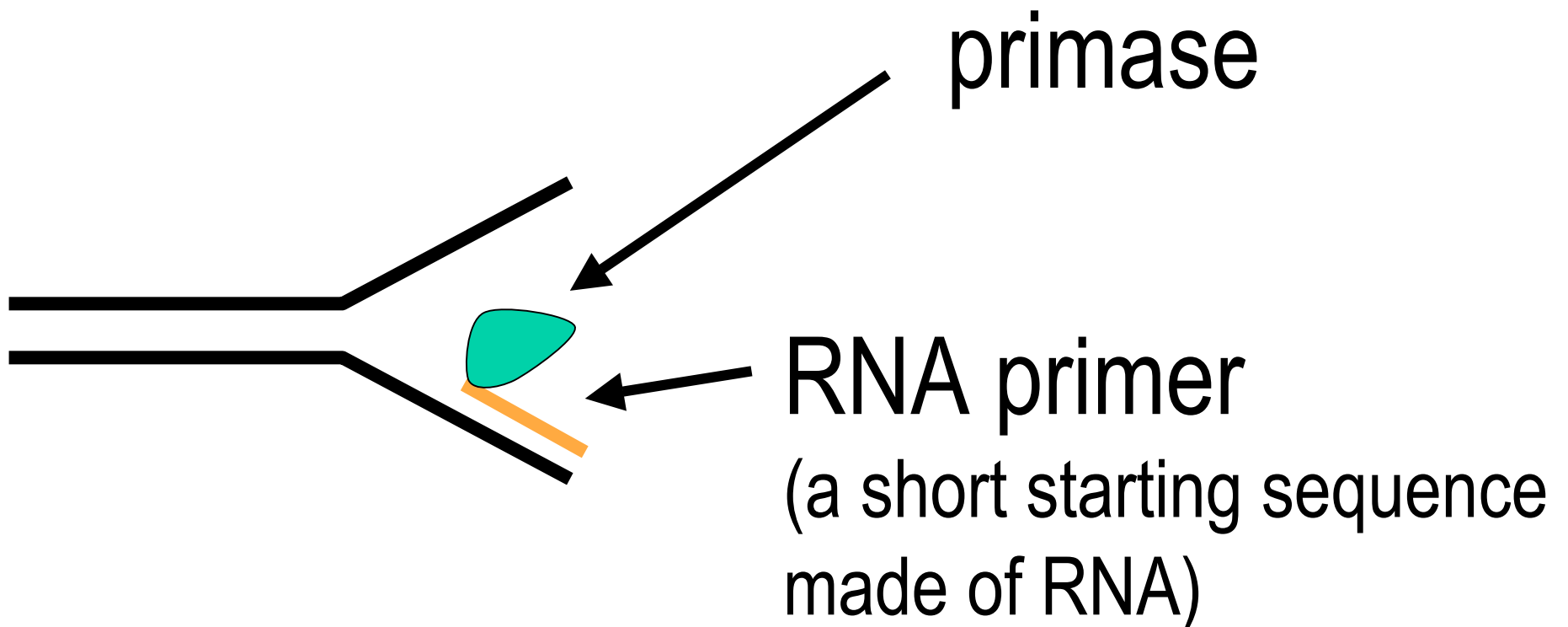

# DNA polymerase III

Synthesizes DNA 5'→3', by priming off the RNA primer on the lagging strand template.

Also has 3'→5' proofreading activity

# DNA polymerase I

Synthesizes DNA from a DNA template and also removes RNA primers from the “Okazaki fragments”.

# DNA ligase

Joins DNA strands together by forming phosphodiester bonds

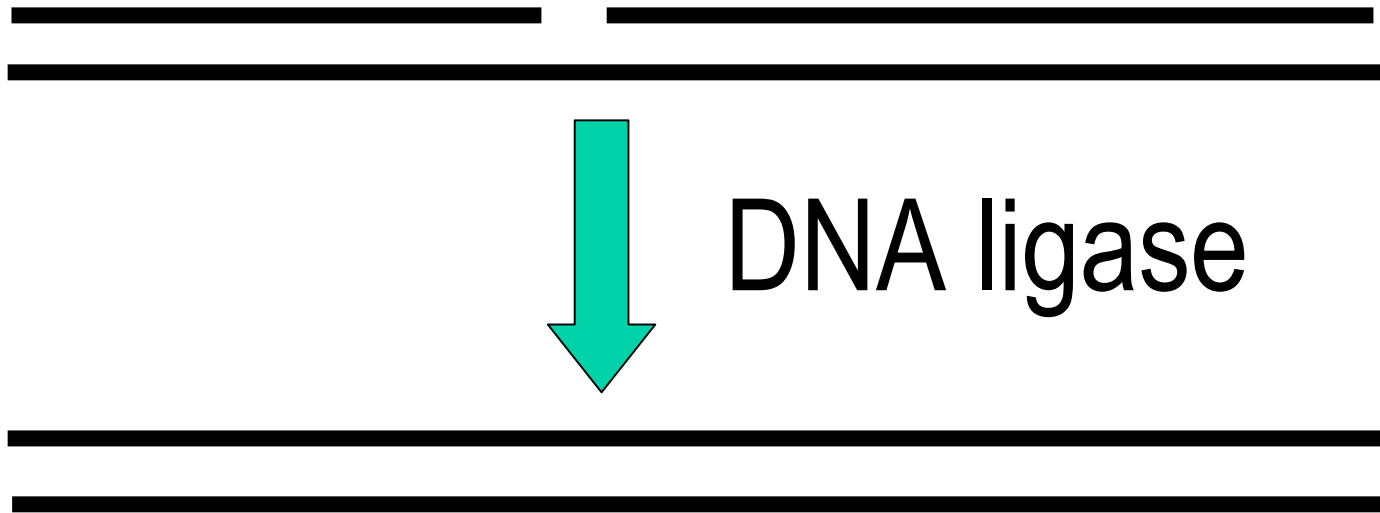



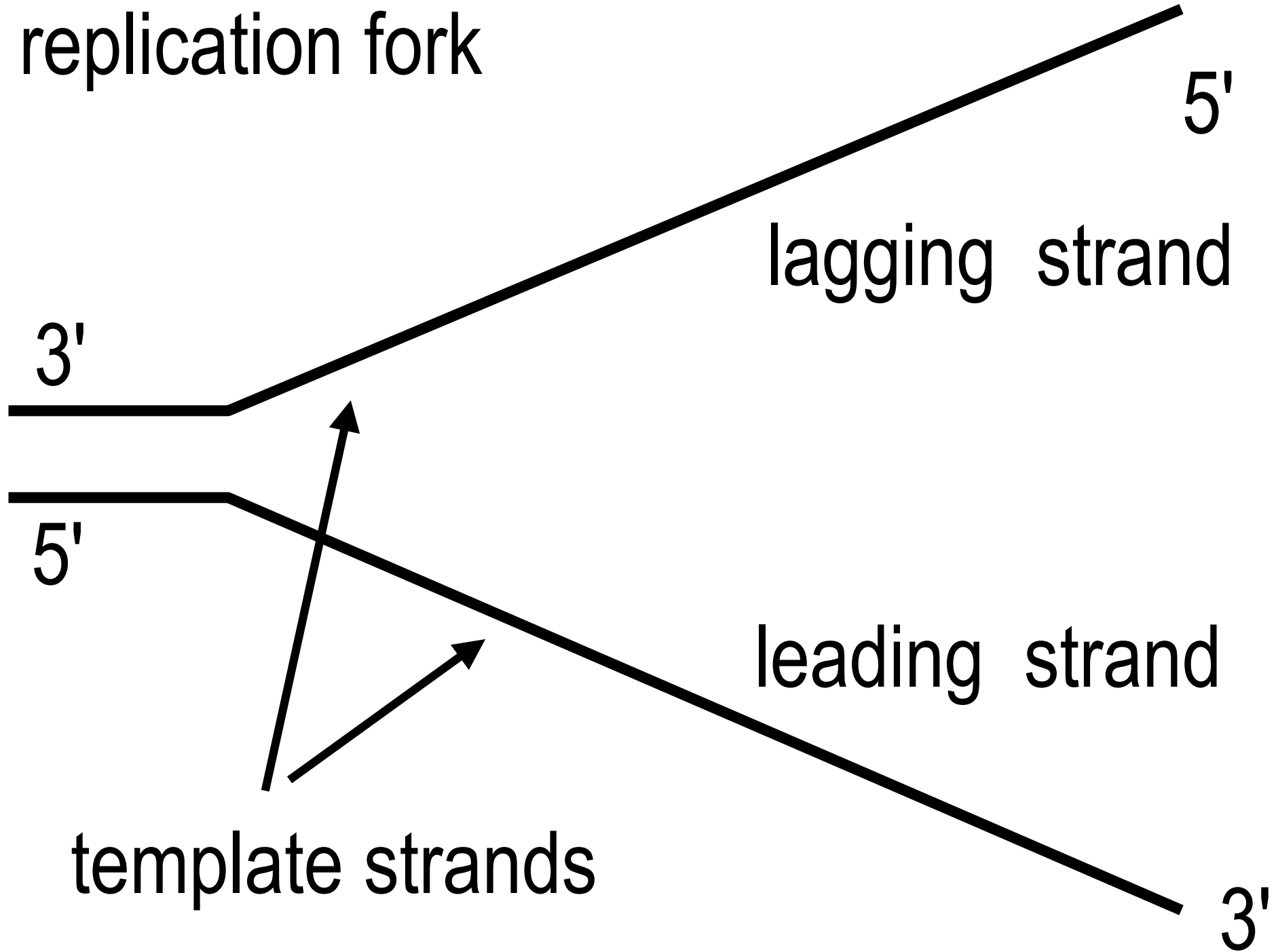

Leading strand  
synthesis

5'

RNA primer

helicase

ssDNA binding proteins

3'

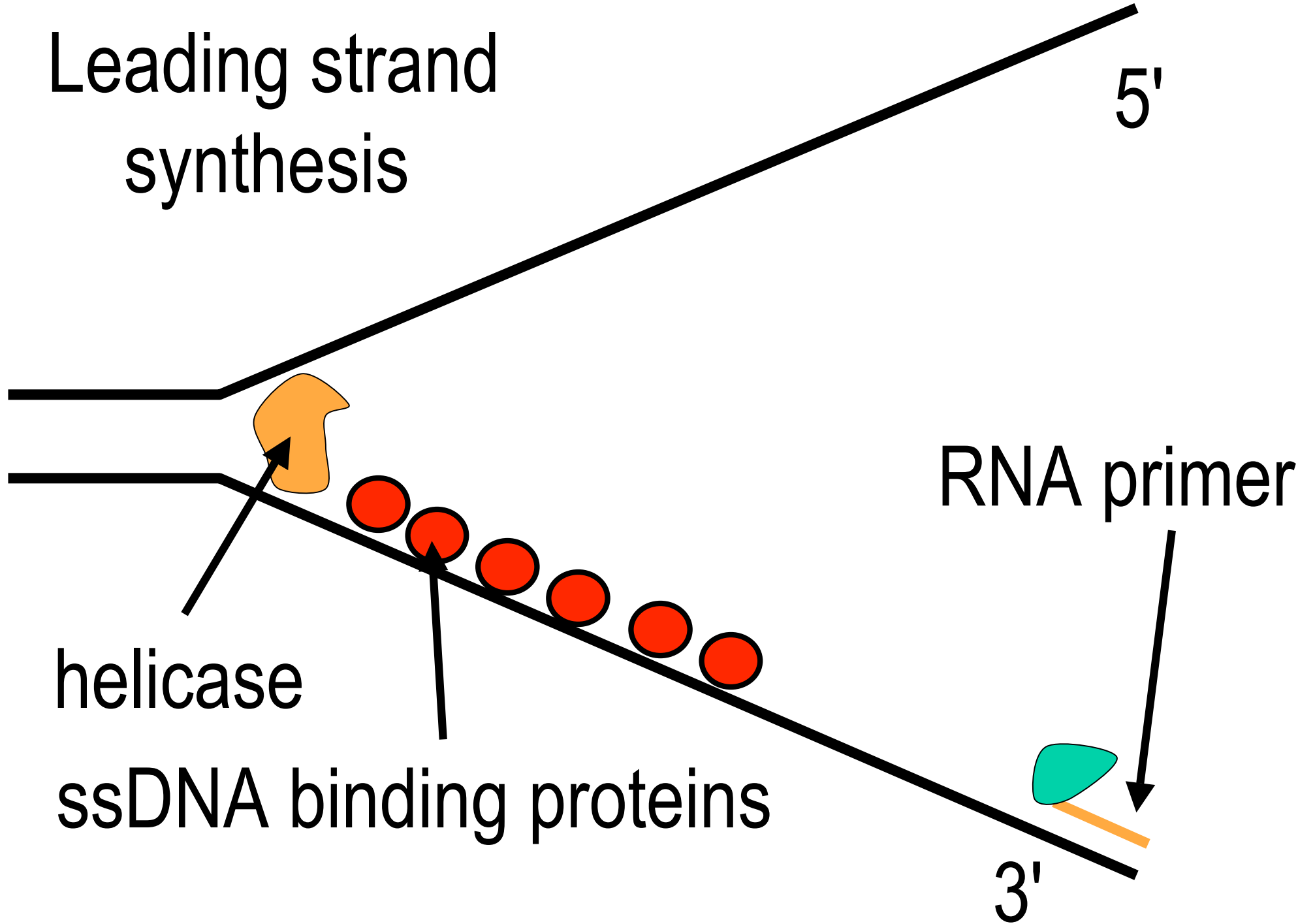

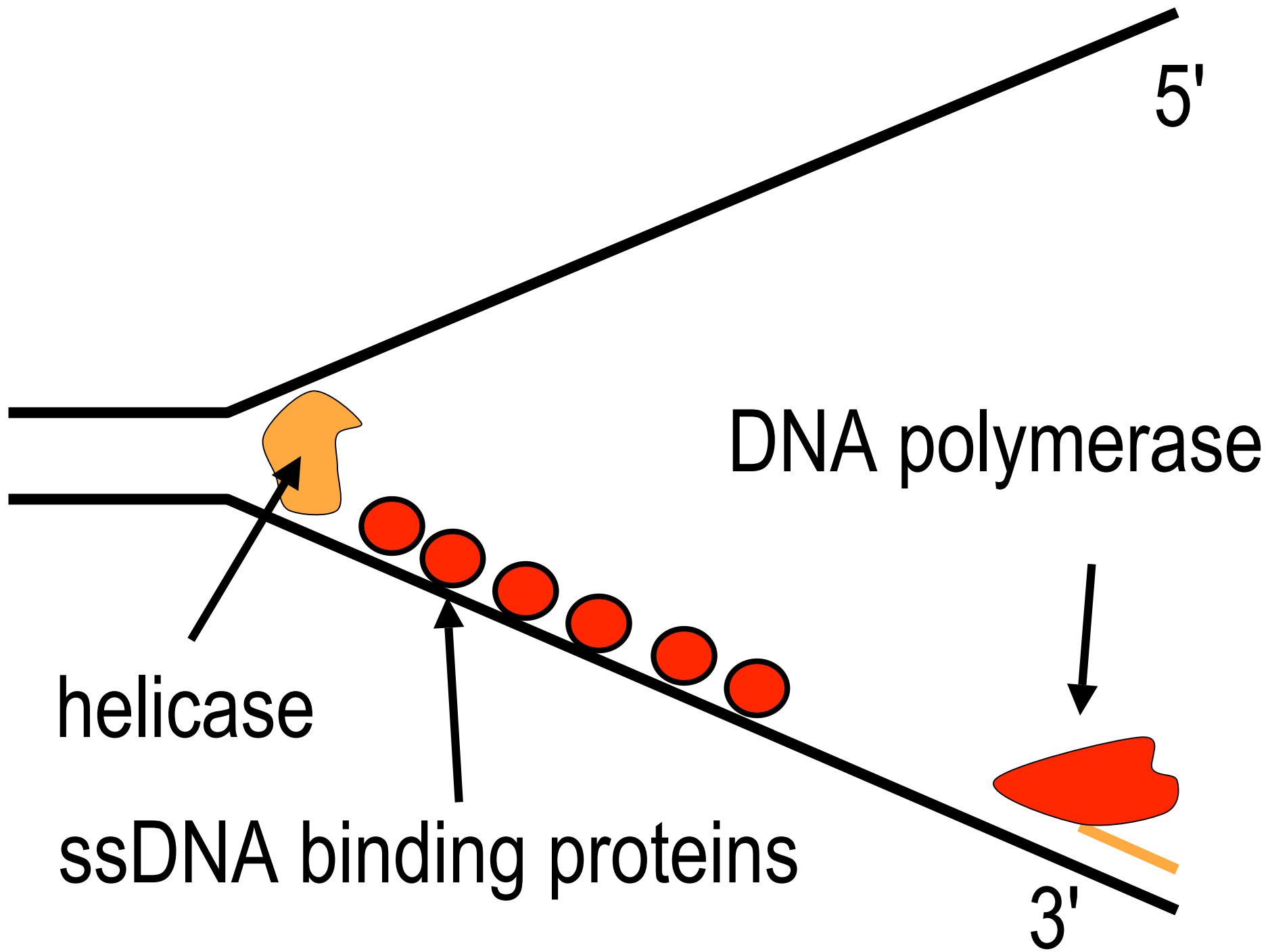

# Leading strand synthesis

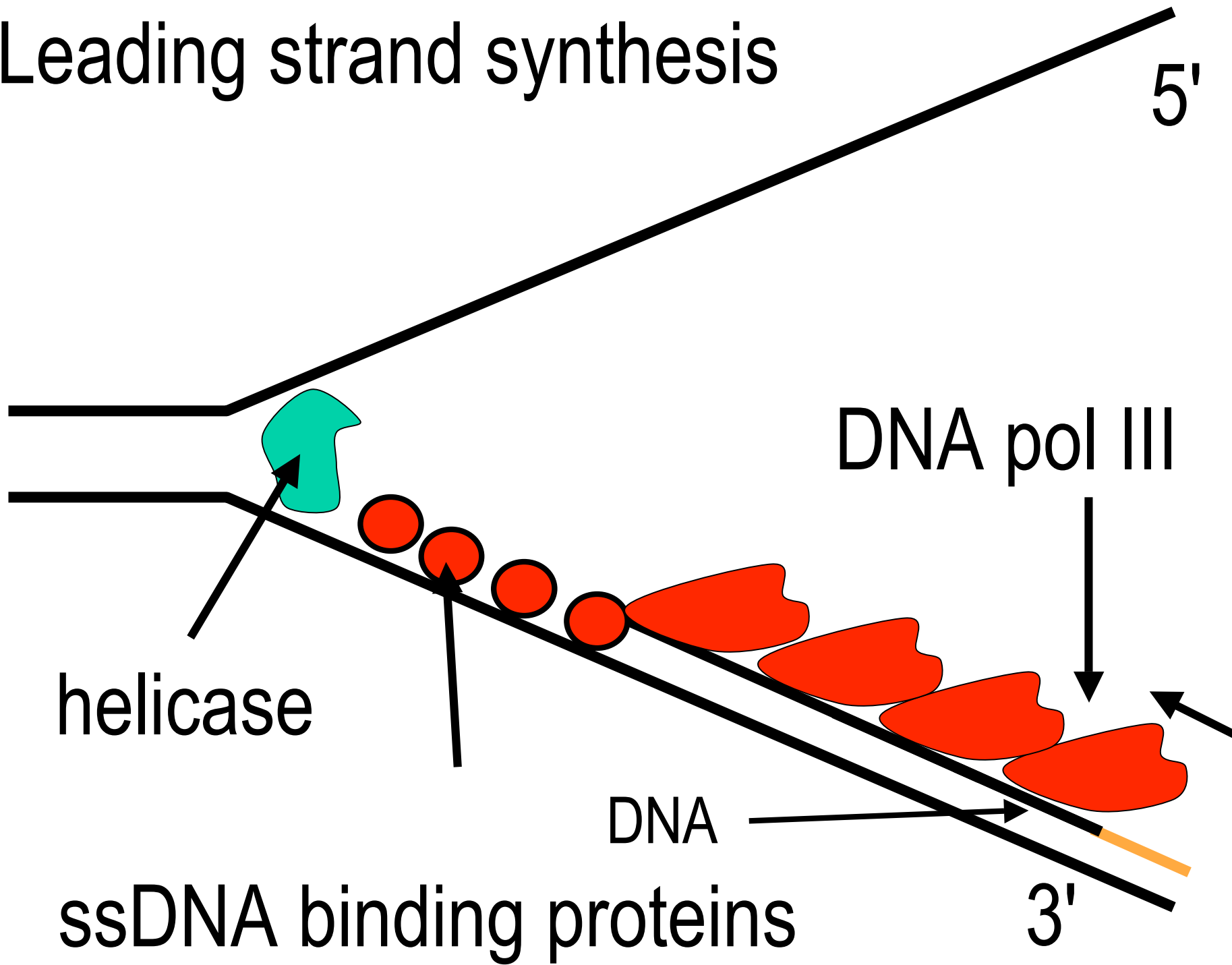

# Proofreading

Pol III removes misincorporated bases using 3' to 5' exonuclease activity

This decreases the error rate to about  $10^{-10}$  per base pair inserted

Diagram of DNA proofreading removed due to copyright restrictions.

See Figure 7-20 in Madigan, Michael, and John Martinko. *Brock Biology of Microorganisms*. 11th ed. Upper Saddle River, NJ: Pearson Prentice Hall, 2006. ISBN: 0131443291.

# Lagging strand synthesis (discontinuous)

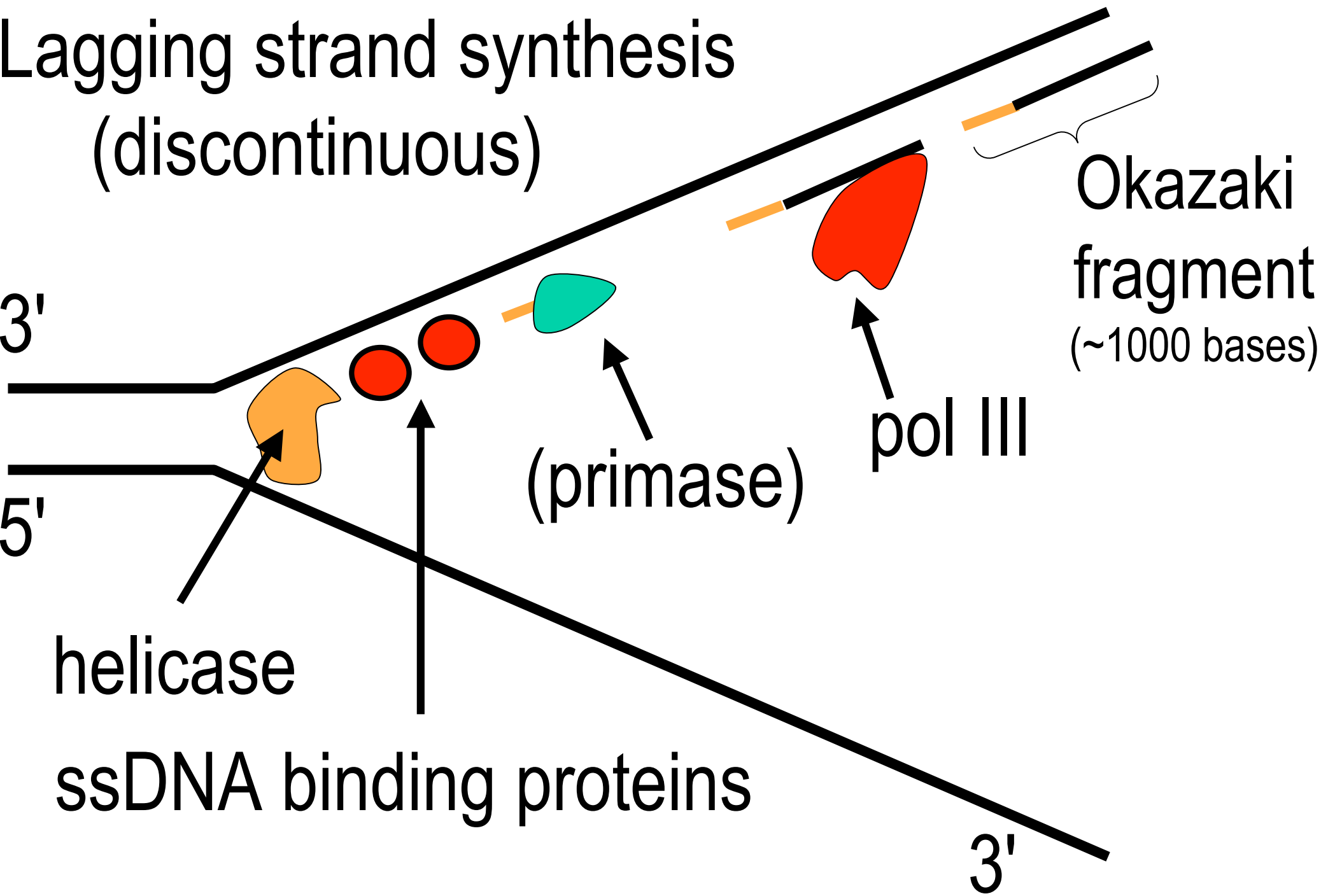

# Primer removal

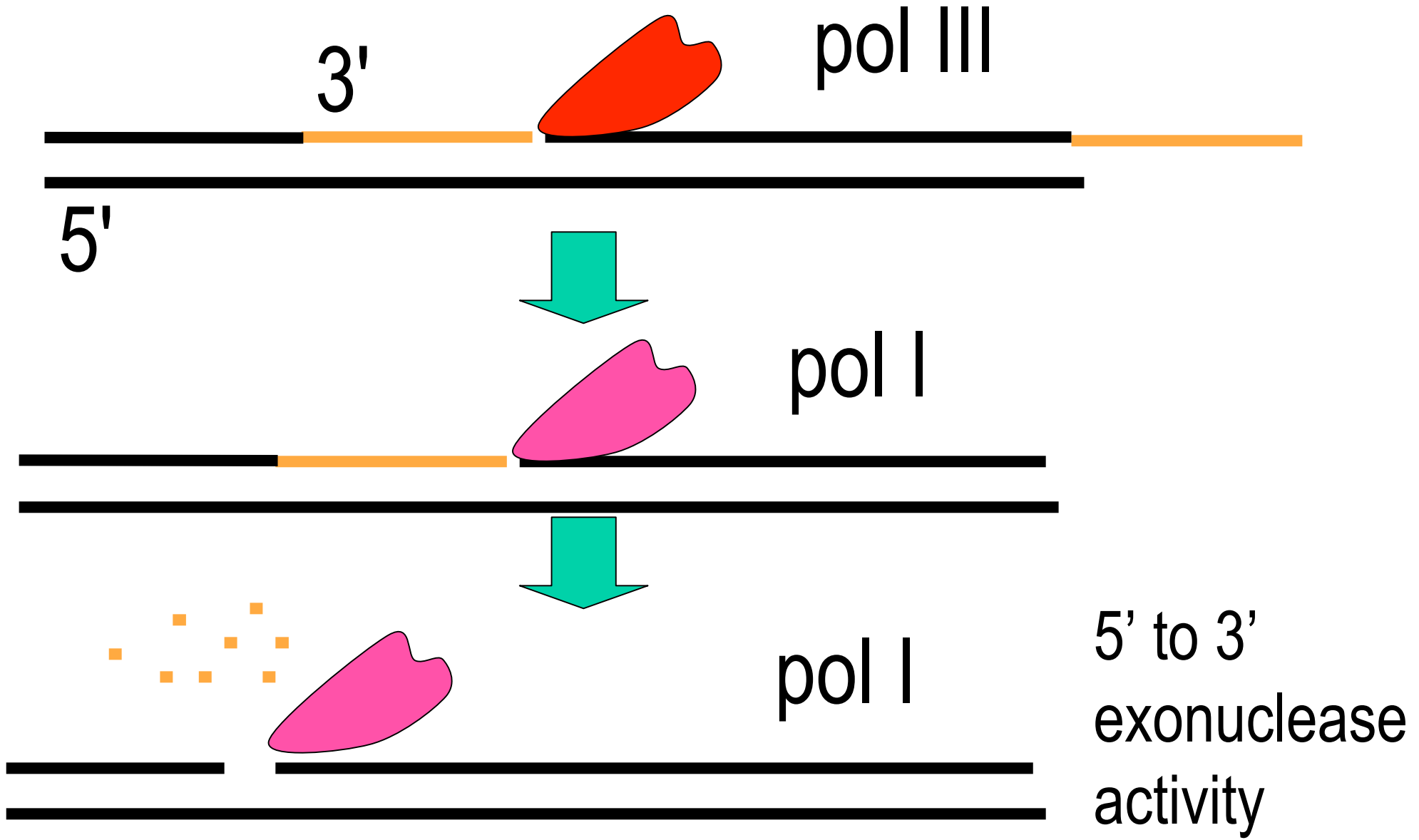

# Ligation

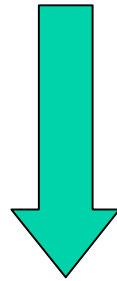

DNA ligase





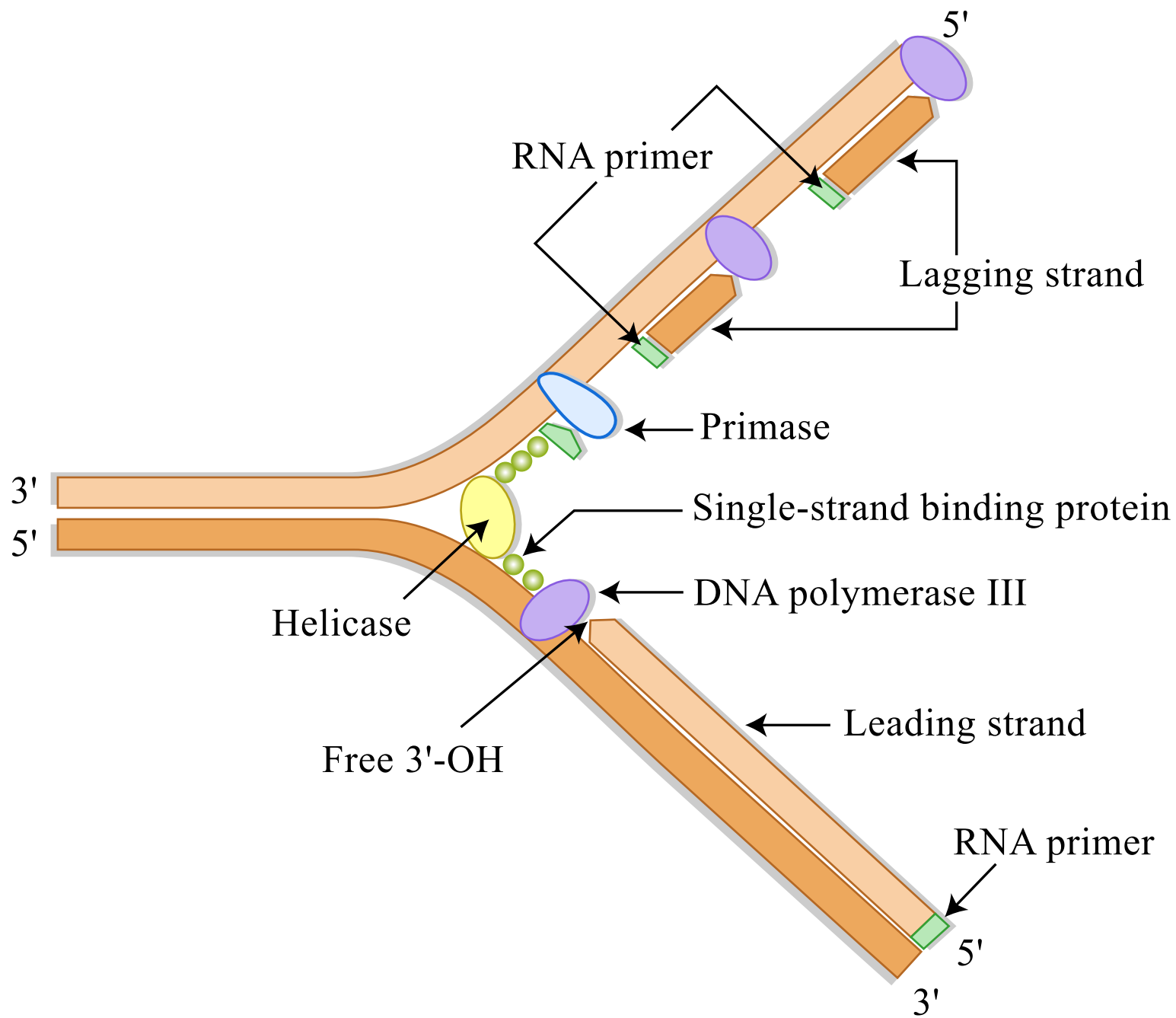
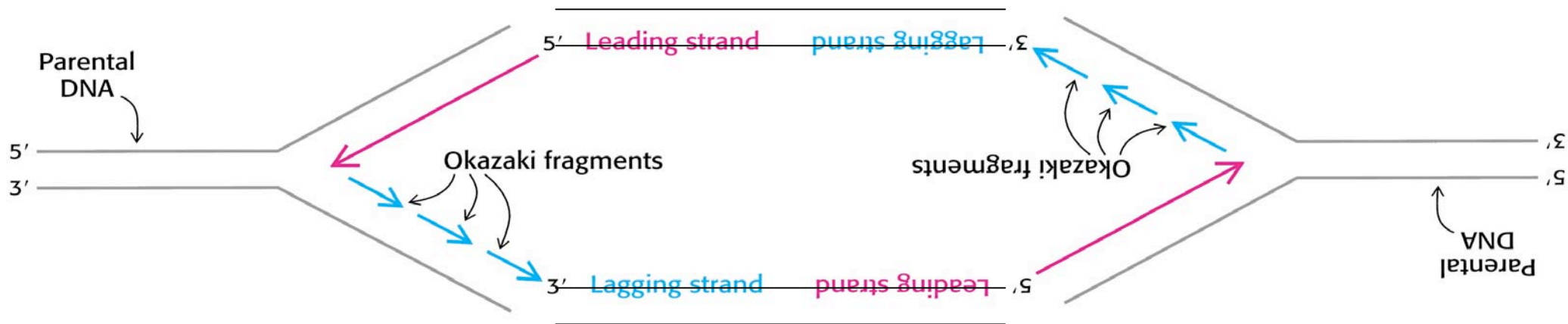

Figure by MIT OCW.

# DNA SYNTHESIS HAPPEN BIDIRECTIONALLY, FROM INITIATION SITE

## “REPLICATION BUBBLE”



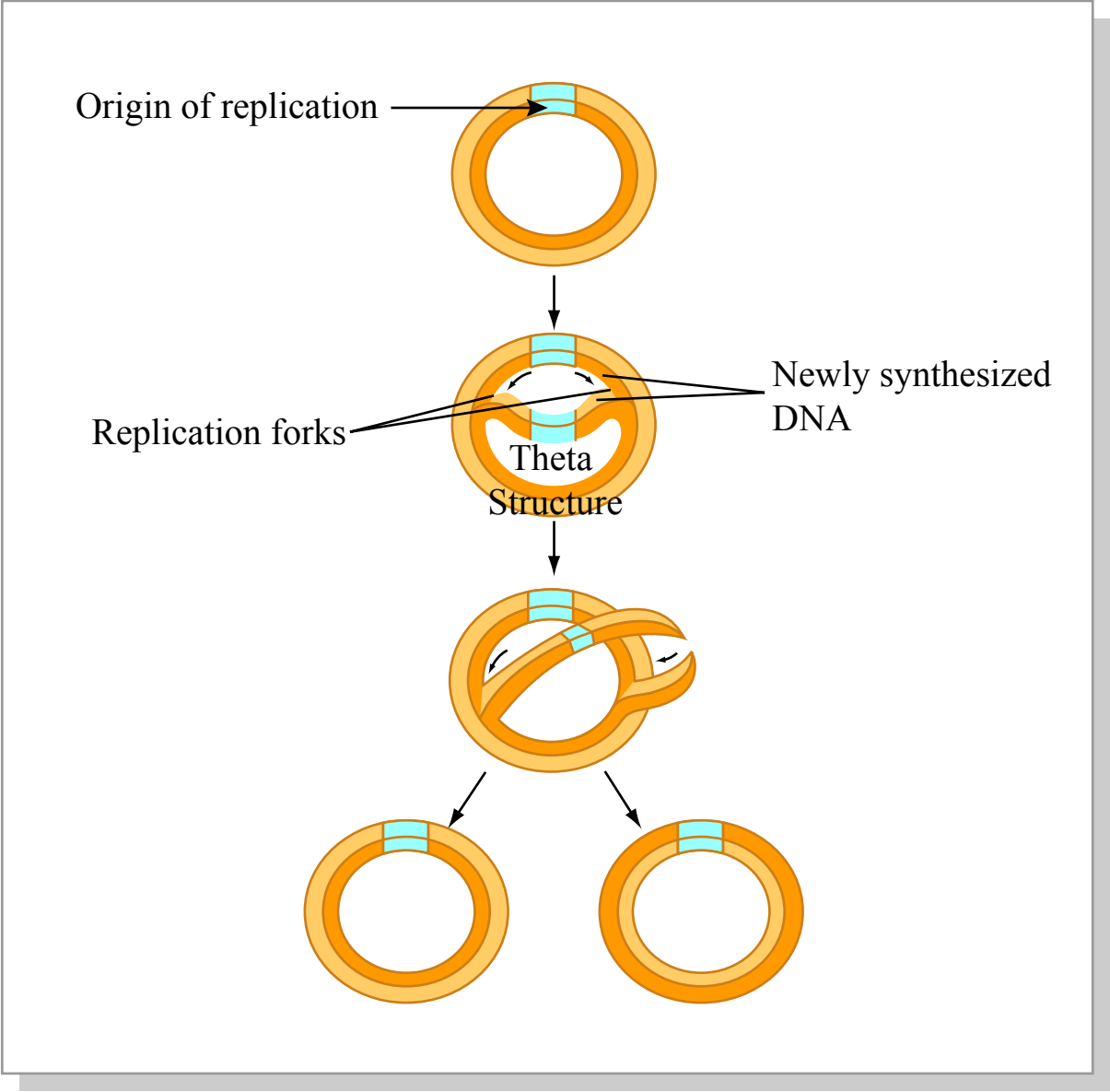
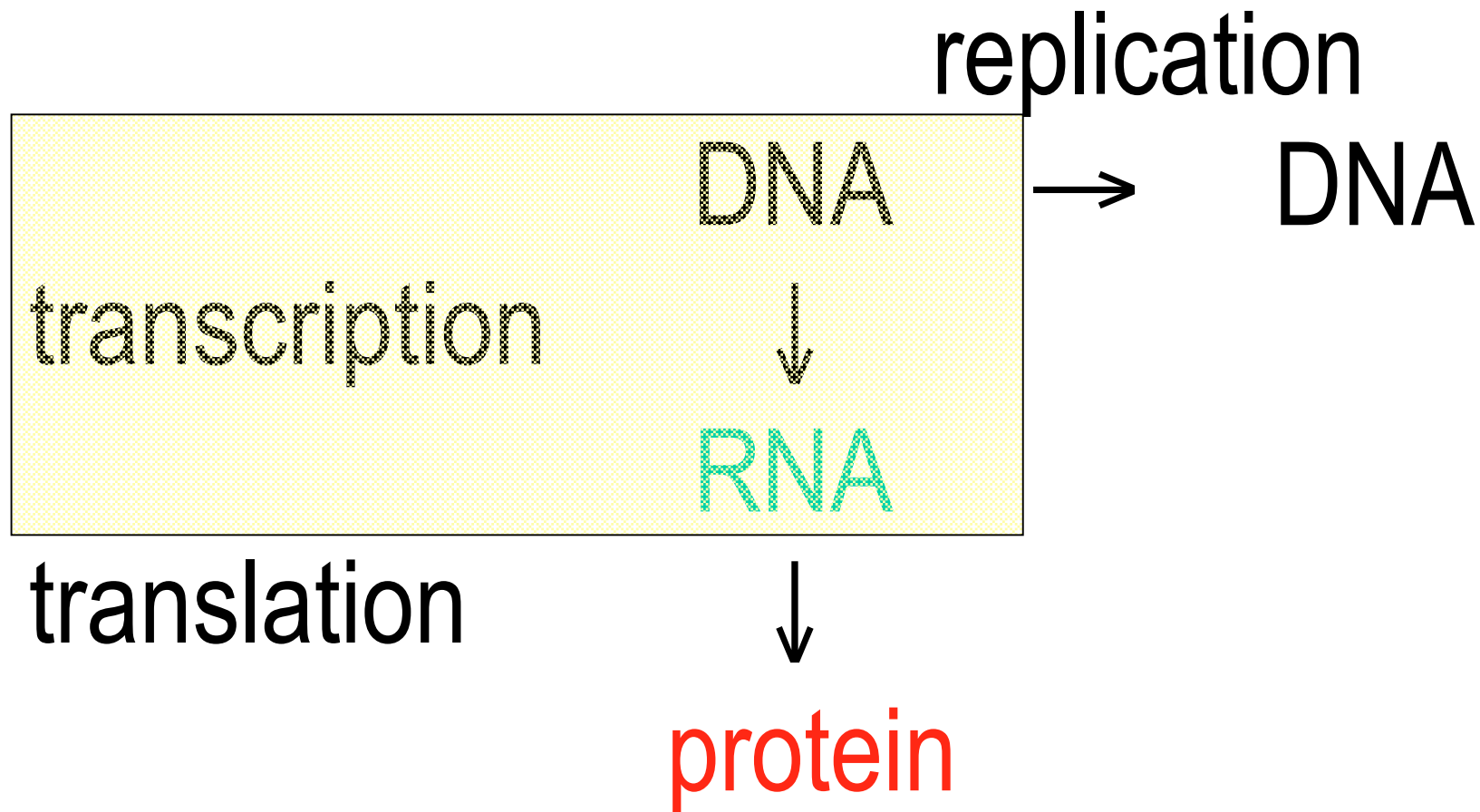

Figure by MIT OCW.

# Flow of information



# Regulatory pathways in prokaryotes

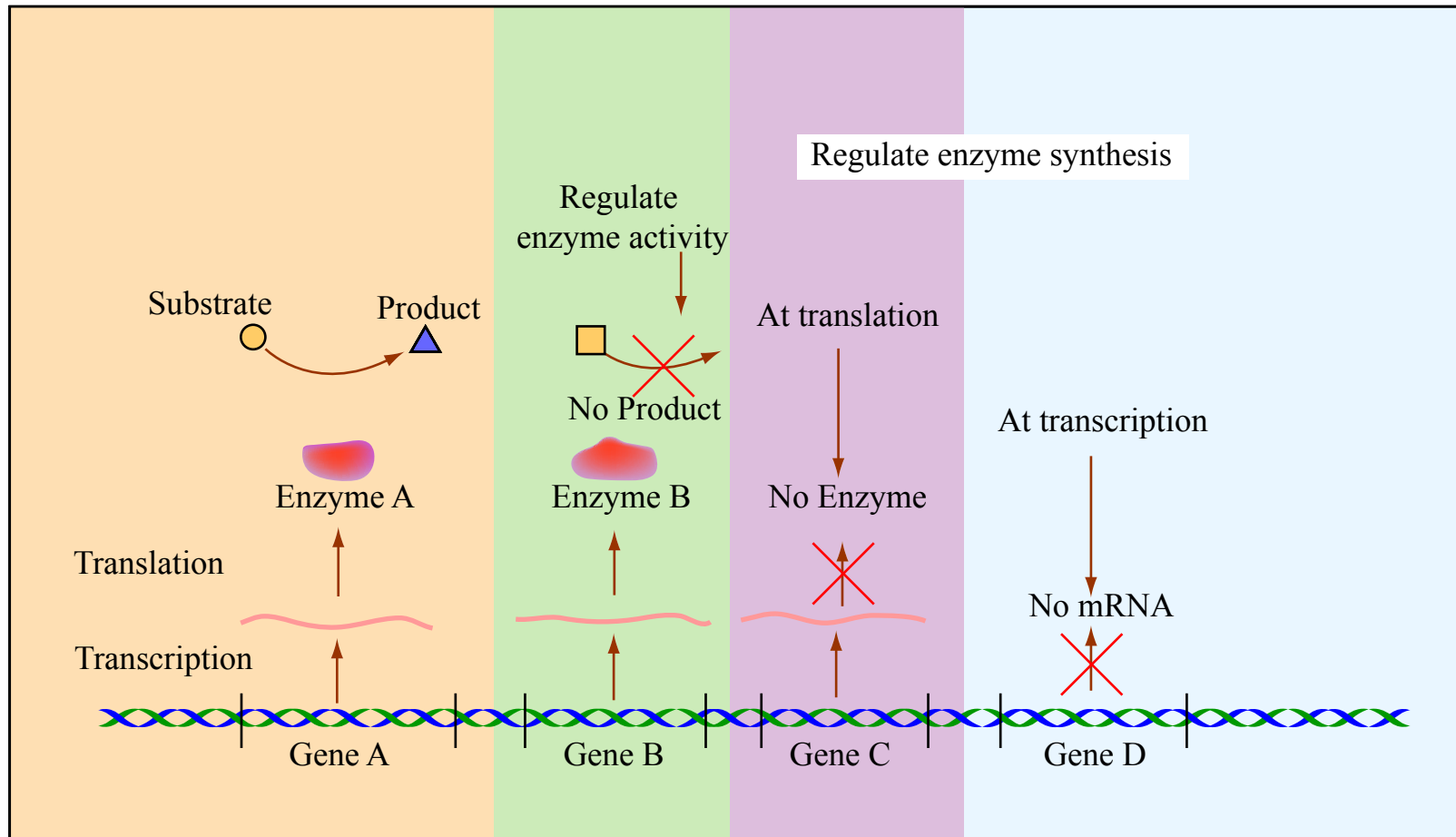

Figure by MIT OCW.

# Prokaryotic transcription

Transcribed regions

RNA polymerase

Promoters

Terminators

Sigma factor

5' end

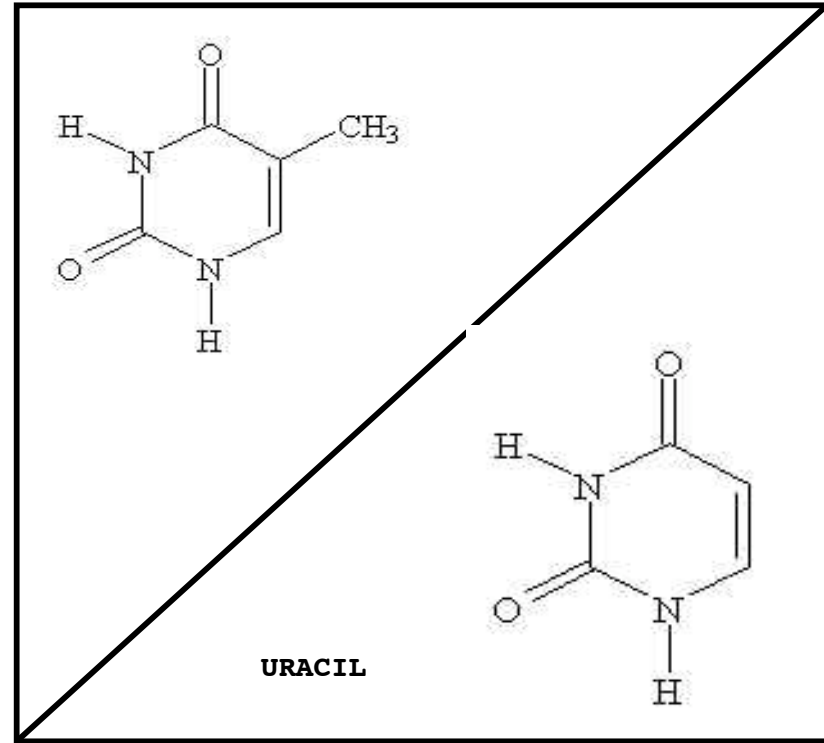
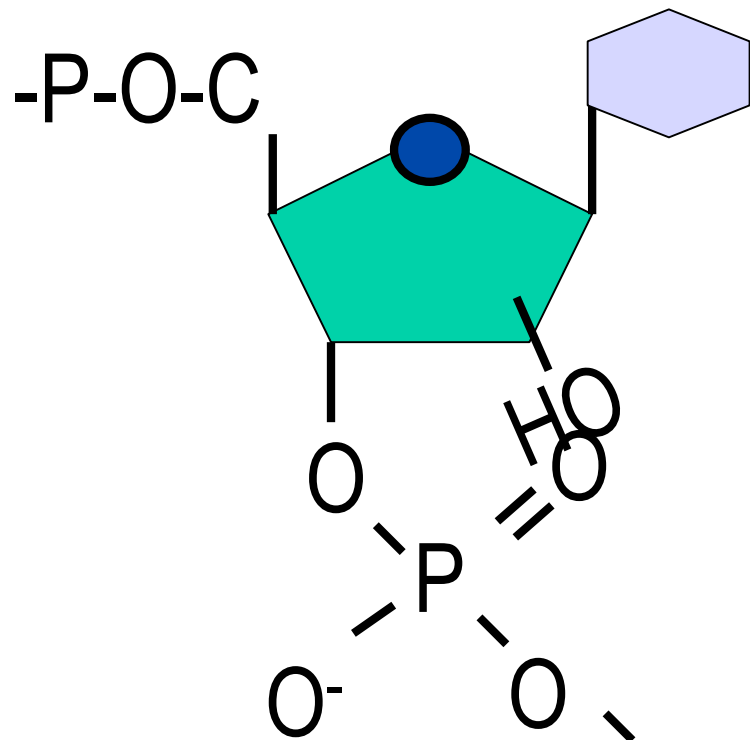

3' end

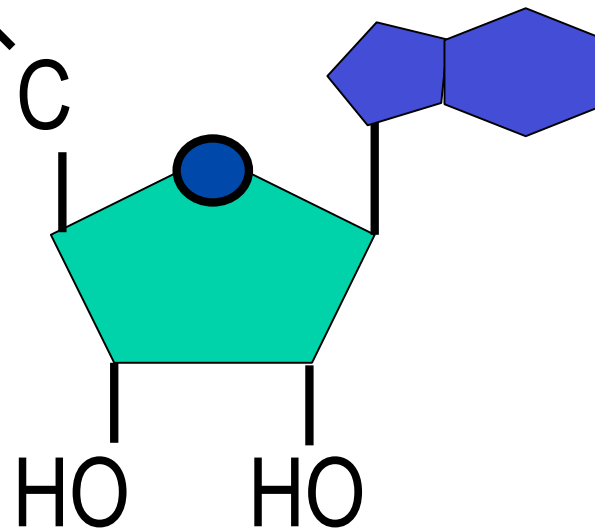

ssDNA

# Transcription

Diagram of RNA transcription removed due to copyright restrictions.

See Figure 7-29a in Madigan, Michael, and John Martinko. *Brock Biology of Microorganisms*. 11th ed. Upper Saddle River, NJ: Pearson Prentice Hall, 2006. ISBN: 0131443291.



# DNA dependent RNA Polymerase (RNAP) recognizes promoter sequence and initiates transcription

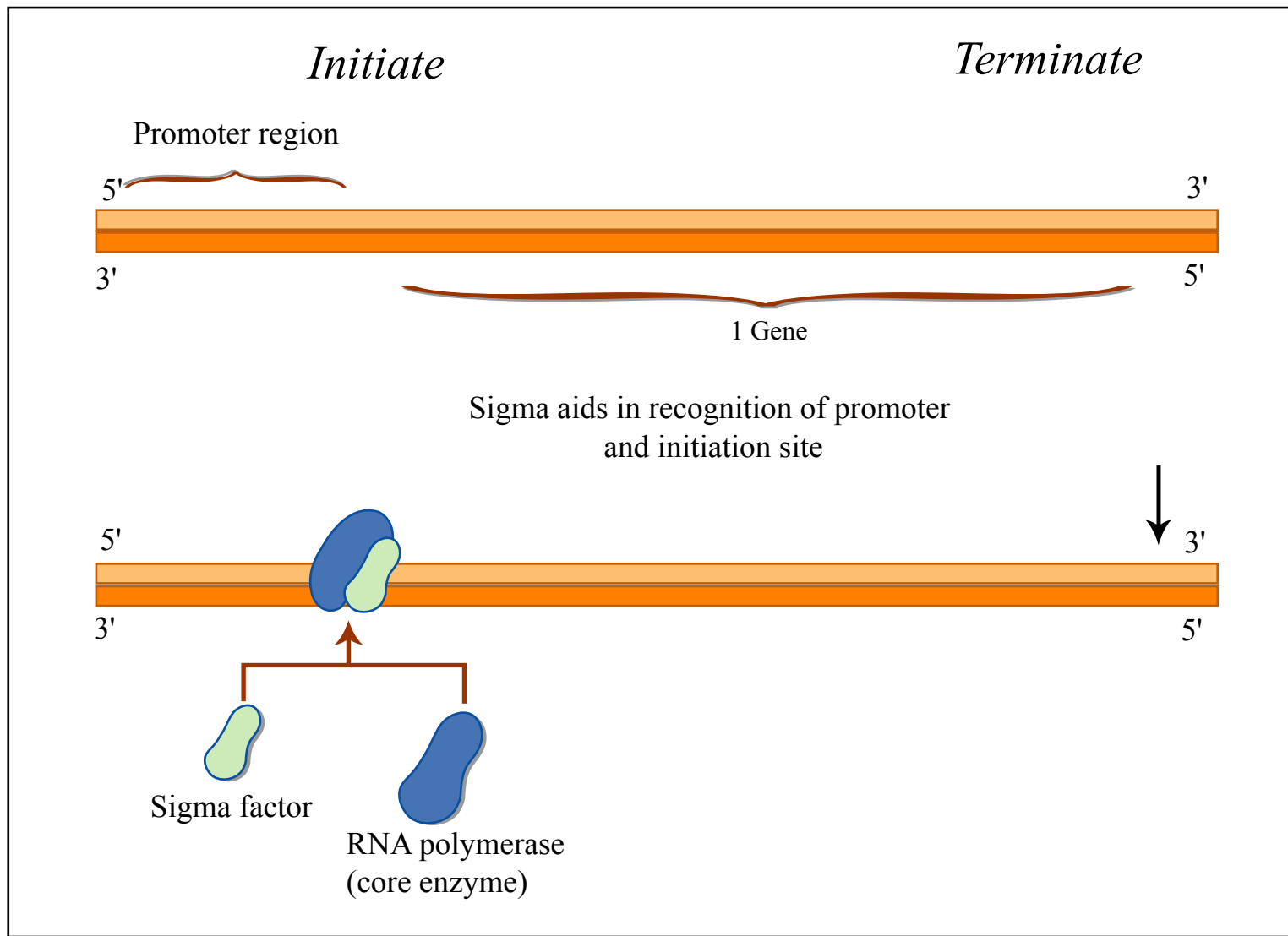

Figure by MIT OCW.

Synthesis of the mRNA transcript (5' → 3')  
complementary to one of the two strands – the  
template strand – sigma dissociates

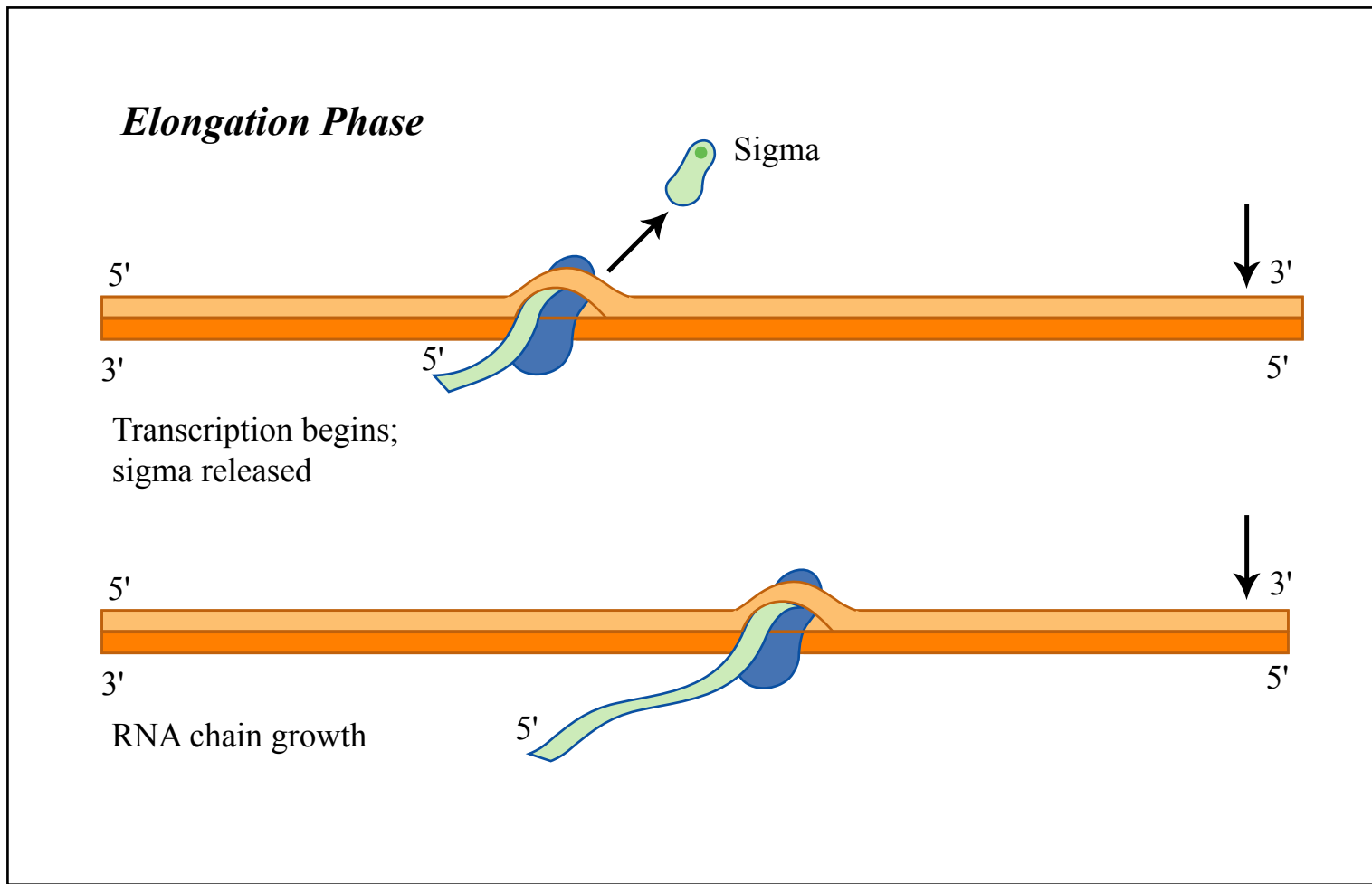

Figure by MIT OCW.

Elongation phase continues until the RNAP reaches a terminator and dissociates

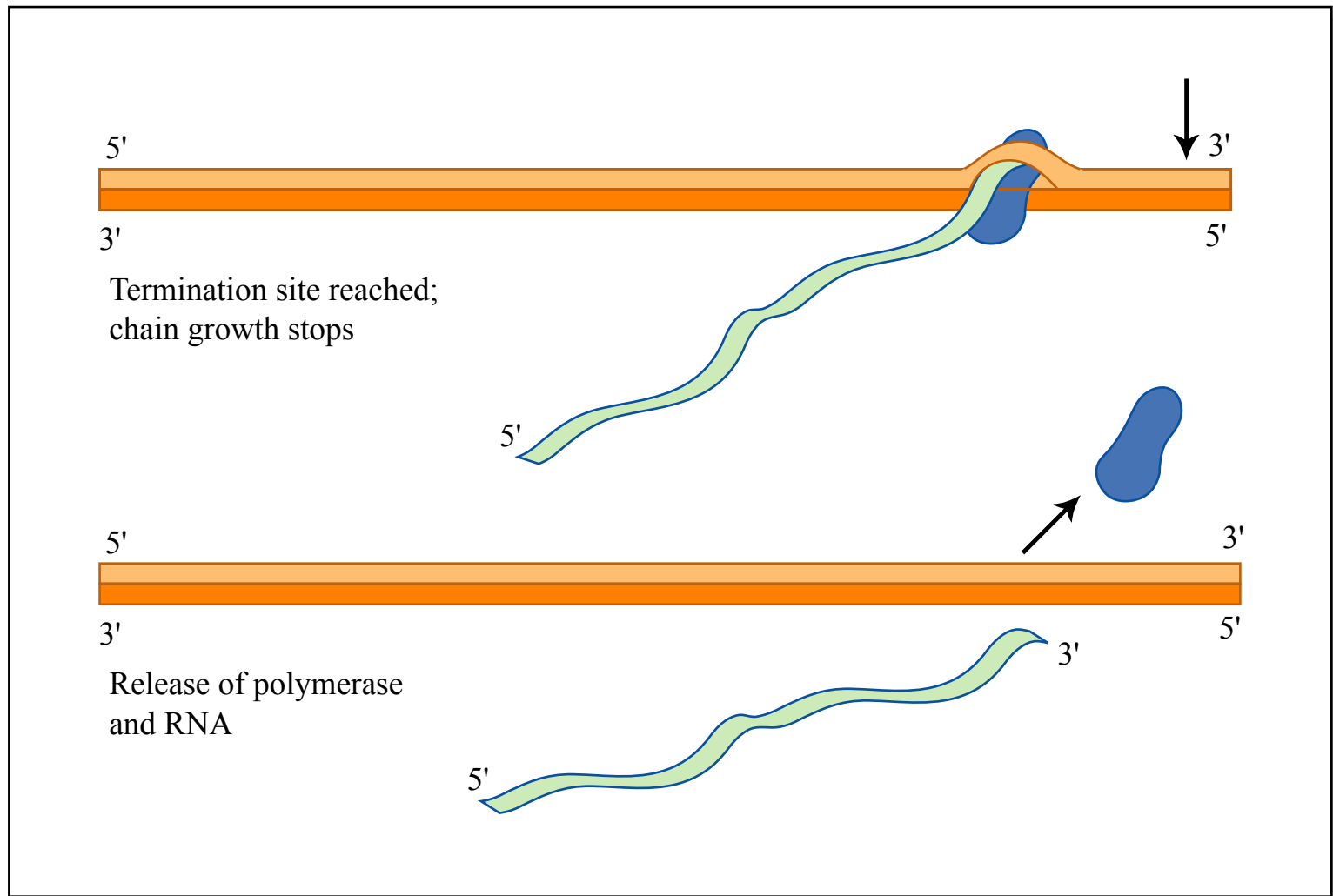

Figure by MIT OCW.

Initiation of transcription begins with promoter binding by  
RNAP holoenzyme

holoenzyme = RNAP core + Sigma

Diagram of RNA polymerase and transcription removed due to copyright restrictions.

# Architecture of a vegetative ( $\sigma^{70}$ ) promoter

-core promoter recognized by sigma factor

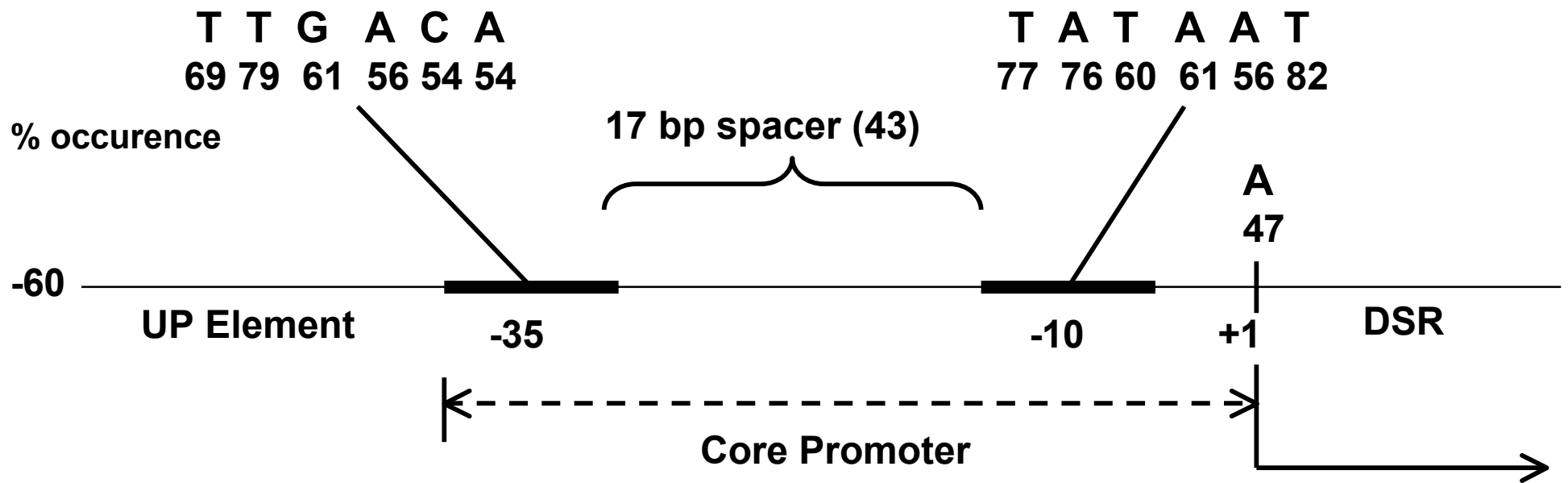

Alternative sigma factors bind to core RNA pol and direct it to different promoters.

*E. coli* RNA pol holoenzyme is  $\alpha_2\beta\beta'\sigma$

Sigma 70 is used for 'normal' promoters

Sigma 32 is used for heat-shock promoters

Sigma 54 is used for N limitation promoters

<b>Gene</b>	<b>Sigma factor</b>	<b>-35</b>	<b>Spacing</b>	<b>-10</b>
<i>rpoD</i>	$\sigma 70$	TTGACA	16-18 bp	TATAAT
<i>rpoH</i>	$\sigma 32$	CCCTTGAA	13-15 bp	CCCGATNT
<i>rpoN</i>	$\sigma 54$	CTGGNA	6 bp	TTGCA

# What dictates the transcriptional activity of a gene?

## Promoter strength

How similar are the promoter core elements (-10,-35, and their spacing) to the consensus?

- in general the more similar they are, the more active the promoter will be to initiate transcription
- however, some positions are more important than others

TTGACA ---17bp---TATAAT---A      Consensus

TCGACA---17bp---TATTAT---A      Strong promoter

TCAGTT---19bp---GATAAC---A      Weaker promoter

# Non-core sequences can affect promoter strength

## 1. Extended $-10$ sequences

some promoters have longer  $-10$  elements

## 2. UP elements

other promoters have AT rich sequences just upstream of the  $-35$  that elevate transcription rate

## 3. Downstream elements

sequences immediately downstream of the start site can affect the overall efficiency of transcription initiation



# Initiation complexes through elongation

Diagram removed due to copyright restrictions.

Karp, 1999, Molecular Cell Biology, Wiley and Sons

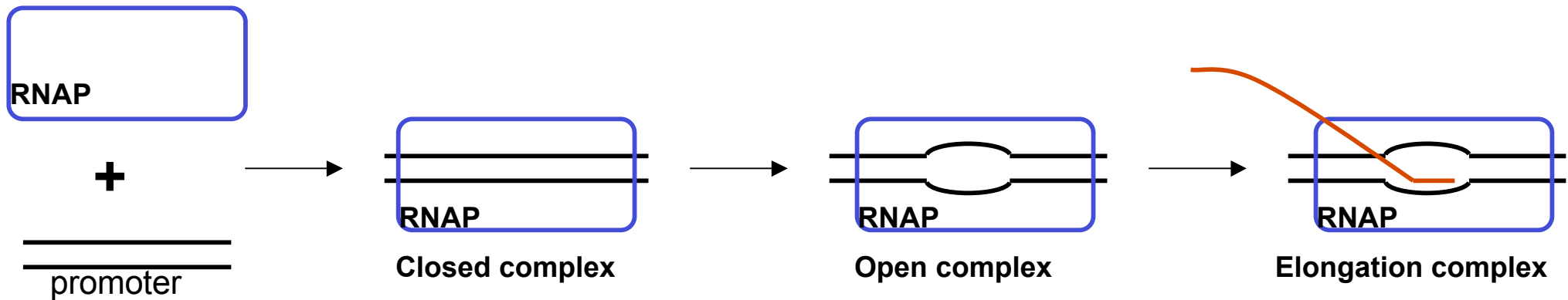

# The transcription cycle

- can be viewed as a cycle

1. Initiation

Diagram removed due to copyright restrictions.

2. Elongation

3. Termination

# Mechanism of transcriptional initiation

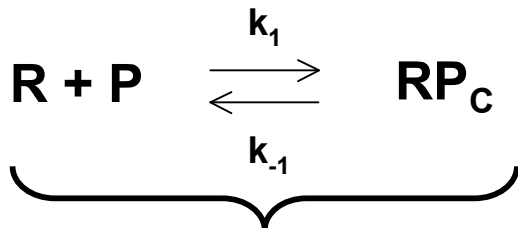

Described by a  
equilibrium constant  
called  $K_1$

$$K_1 = RP_C / (R + P)$$

R – RNAP

P – Promoter

RPC – closed complex

RPO – open complex

RPI – initiation complex

RPE- elongation complex

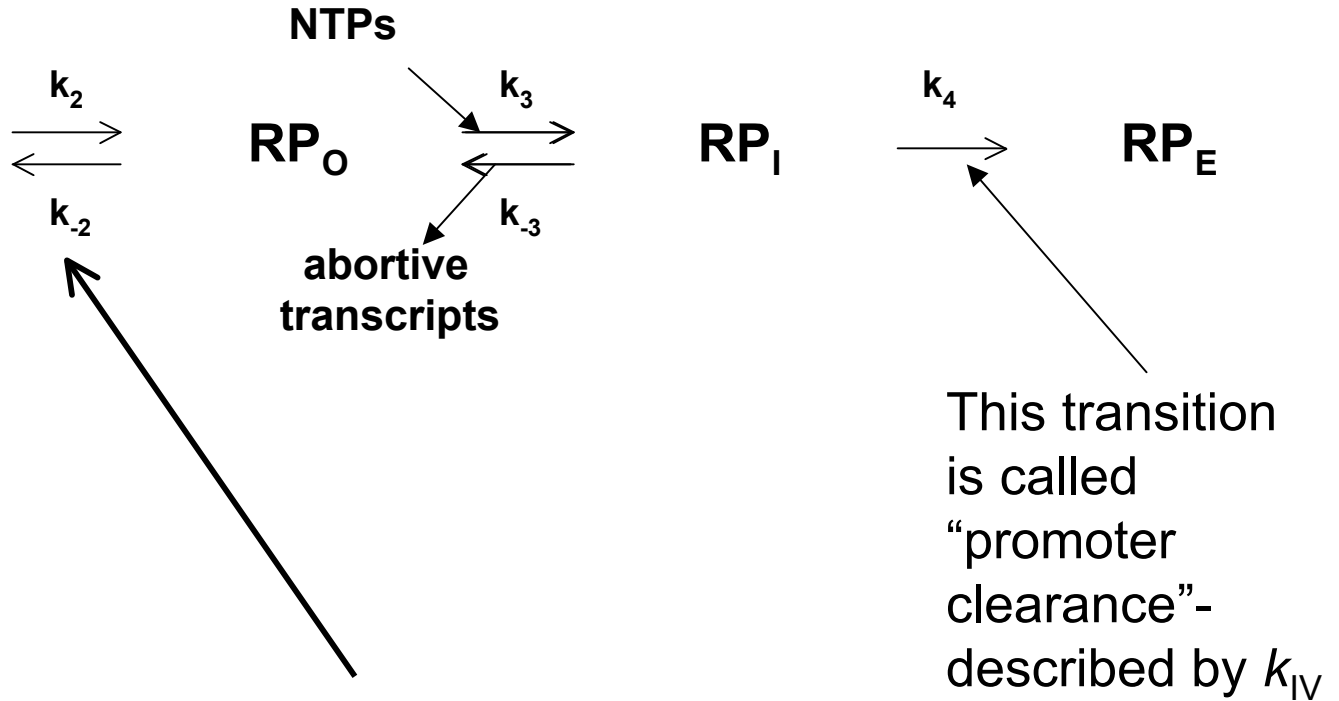

The rate of open  
complex formation is  
often called  $k_{11}$

This transition  
is called  
"promoter  
clearance"-  
described by  $k_{IV}$

# Transcription termination

Diagram of transcription termination removed due to copyright restrictions.

See Figure 7-32 in Madigan, Michael, and John Martinko. *Brock Biology of Microorganisms*. 11th ed. Upper Saddle River, NJ: Pearson Prentice Hall, 2006. ISBN: 0131443291.

# Some differences between eukaryotic & prokaryotic transcription.

Eukaryotic mRNAs are usually spliced, capped and tailed, in the nucleus.

Eukaryotes do NOT have classical operons.

RNA polymerase structure/function differ

Initiation complexes differ Sigma factor vs. TBP

Prokaryotic genes very very rarely have introns

# DRUGS THAT INHIBIT TRANSCRIPTION &/or DNA REPLICATION

---

ANTIBIOTIC	TARGET; MODE OF ACTION
<b>Actinomycin D</b>	<b>Transcription;</b> inhibits DNA-dependent RNA synthesis by binding DNA
<b>Adriamycin HCl</b>	<b>DNA replication &amp; Transcription;</b> Inhibits DNA and RNA synthesis by binding DNA
<b>Aphidicolin</b>	<b>DNA replication ;</b> Inhibits alpha-type polymerase (eukaryotic and viral)
<b>Bleomycin sulfate</b>	<b>DNA replication ;</b> reacts with DNA and causes chain break
<b>Chromomycin A<sub>3</sub></b>	<b>Transcription ;</b> Inhibitor of DNA-dependent RNA-synthesis
<b>Mithramycin A</b>	<b>Transcription ;</b> inhibits RNA synthesis by complexing with DNA
<b>Mitomycin C</b>	<b>DNA replication ;</b> Anti-tumor antibiotic. Binds covalently to DNA
<b>Nalidixic acid</b>	<b>DNA replication;</b> Inhibitor of bacterial DNA gyrase (a topoisomerase inhibitor)
<b>Netropsin</b>	<b>DNA replication;</b> Peptide antibiotic. Binds to AT-rich regions in the minor groove of DNA
<b>Novobiocin</b>	<b>DNA replication;</b> Inhibitor of bacterial DNA gyrase
<b>Rifampicin</b>	<b>Transcription ;</b> Inhibitor of DNA-dependent RNA-polymerase
<b>Novobiocin</b>	<b>DNA replication;</b> Causes DNA methylation and DNA strand breaks

---

# Translation

**Coupled transcription/translation**

**Compartmentalization/transcript processing**

Diagram of transcription and translation in prokaryotes vs. eukaryotes removed due to coypyright restrictions.

# Coupled transcription/translation

Microscopic photographs of transcription and translation removed due to copyright restrictions.



# Flow of information

replication  
DNA → DNA

transcription



RNA



protein

translation

# Overview of prokaryotic translation

Protein synthesis from an mRNA template.

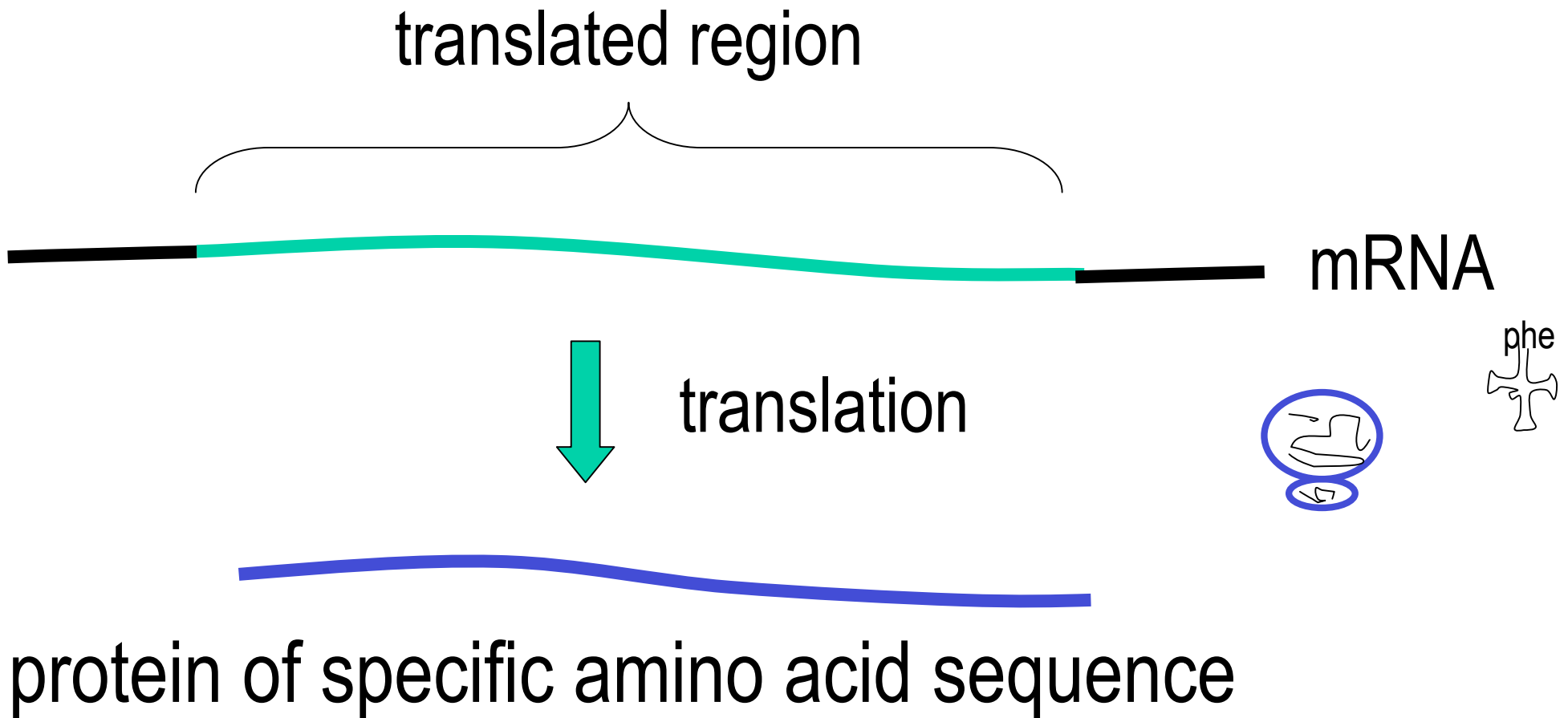

# Key components of translation

Messenger RNA

Transfer RNA

ribosomes and rRNA

# Simple structure of a prokaryotic gene

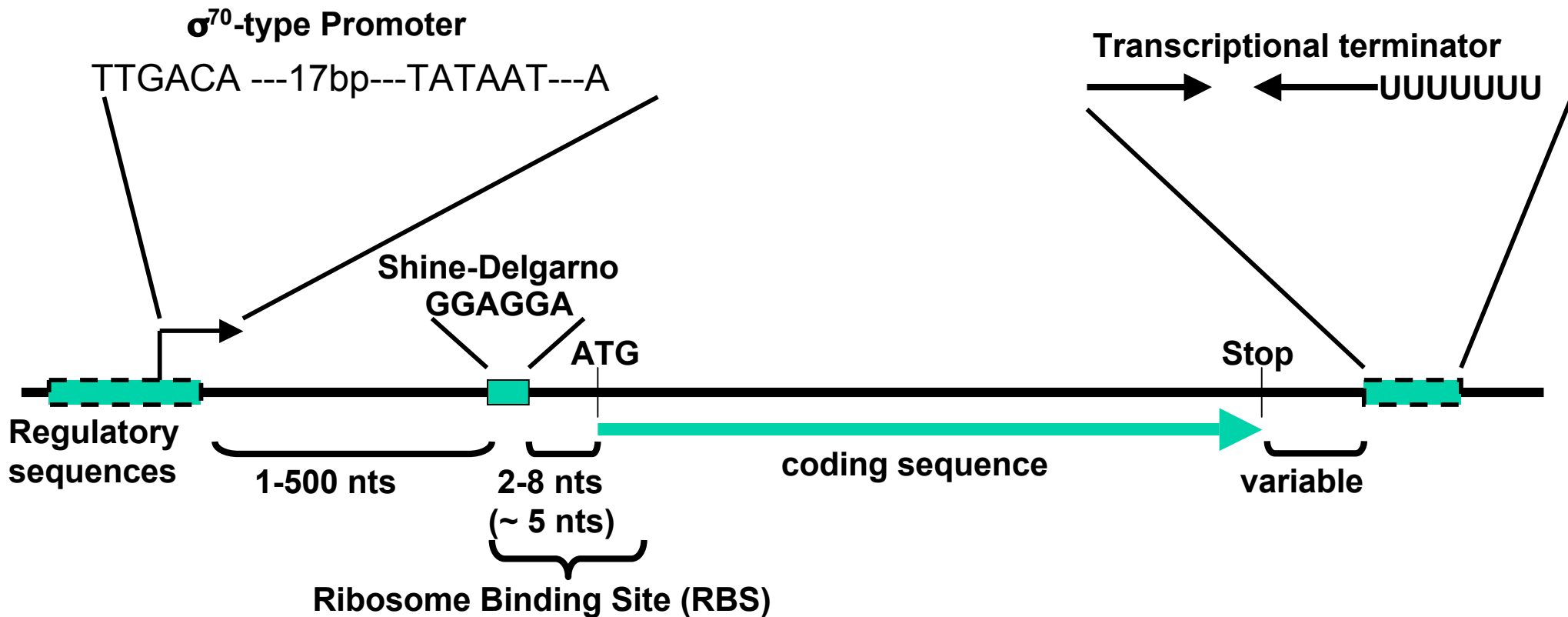

# Shine-Dalgarno sequence

~AGGAGG, ribosome binding sequence,  
critical for ribosome binding

## Start codons

AUG, GUG, or UUG

## Stop codons (nonsense codons)

UAA, UGA, or UAG

Secondary Structure: small subunit ribosomal RNA

Secondary Structure: small subunit ribosomal RNA  
Reference Sequence Numbering System

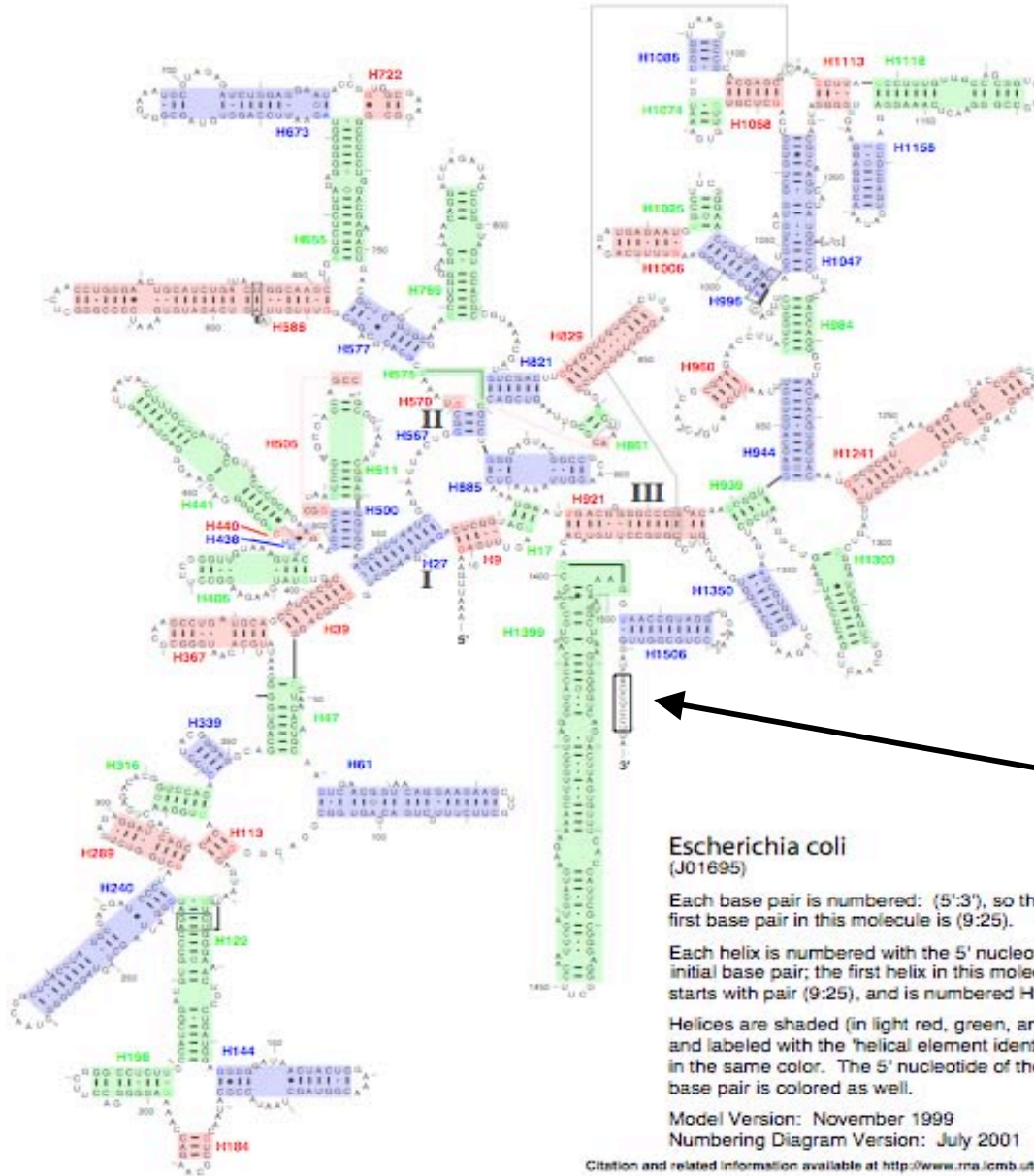

5' mRNA AGGAGGU 3'  
3' rRNA UCCUCCA 5'

Shine Delgamo seq.

Blue = Universal sites

# THE GENETIC CODE

- Series of codons that determines the amino acid sequence of the encoded protein.
- Coding sequences have an average of about 300 codons.
- Except for the stop codon, each codon specifies a particular amino acid.

# The genetic code

Table of the genetic code removed due to copyright restrictions.

See Table 7-5 in Madigan, Michael, and John Martinko. *Brock Biology of Microorganisms*. 11th ed. Upper Saddle River, NJ: Pearson Prentice Hall, 2006. ISBN: 0131443291.



The genetic code is degenerate.

more than one codon can code  
for the same amino acid

UUU → phenylalanine

UUC → phenylalanine

# Synonyms

Different codons can code for the same amino acid

UUU → phenylalanine

UUC → phenylalanine

Not all synonyms are used with equal frequency. This is called "codon usage bias".

# Codon families

CUU

CUC

CUA

CUG

any nucleotide in  
the 3rd positions

leucine

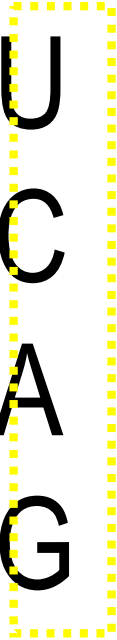

# Codon pairs

any pyrimidine in  
the 3rd position

UUU

UUC

phenylalanine

CAA

CAG

glutamine

any purine in  
the 3rd position

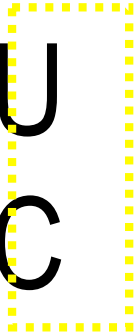

# Codons consist of 3 bases

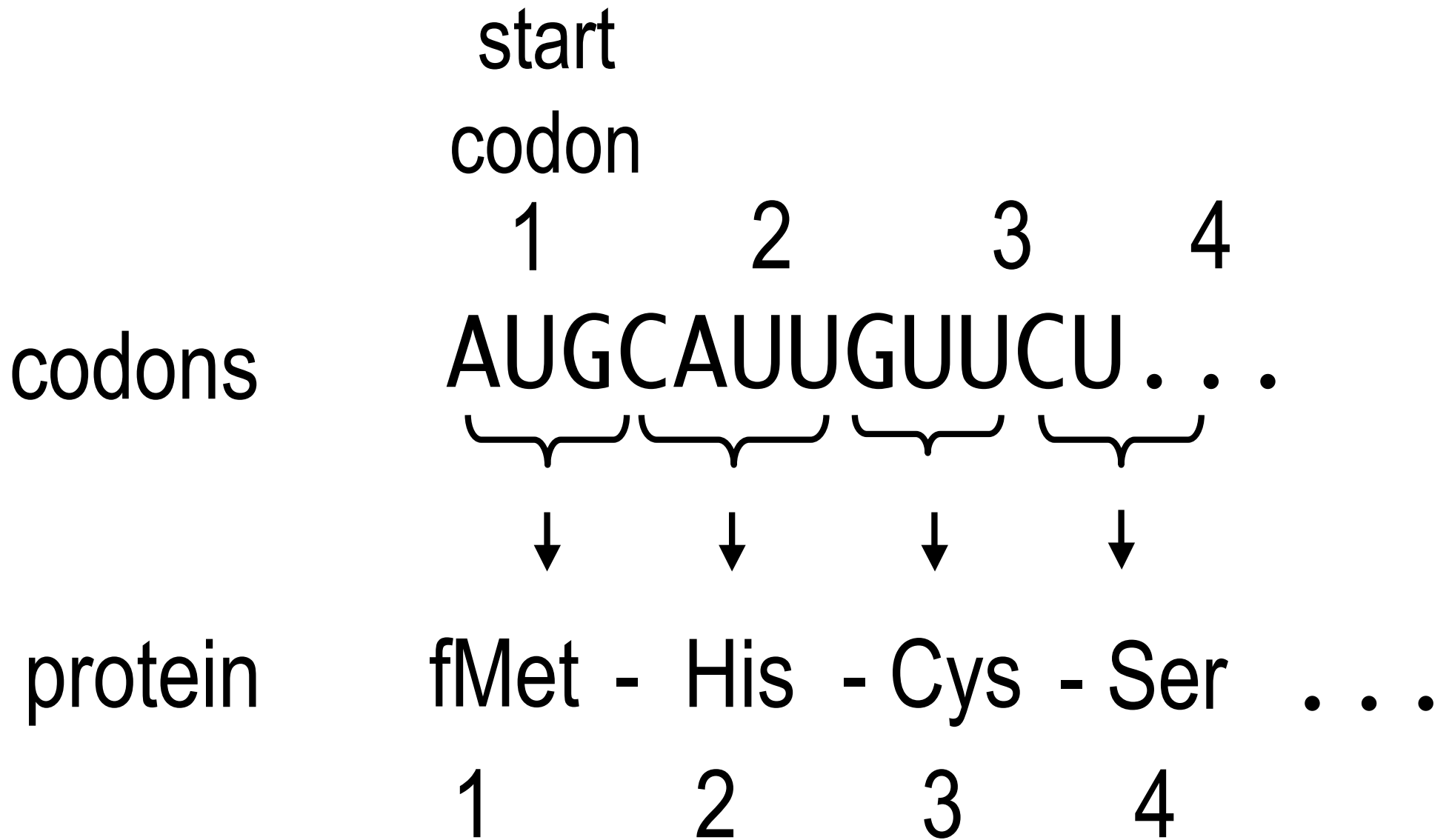

# Reading frames

**TTC TCA TGT TTG ACA GCT**

RF1 Phe Ser Cys Leu Thr Ala>

RF2 Ser His Val \*\*\* Gln Leu>

RF3 Leu Met Phe Asp Ser>

**AAG AGT ACA AAC TGT CGA**

RF4 <Glu \*\*\* Thr Gln Cys Ser

RF5 <Glu His Lys Val Ala

RF6 <Arg Met Asn Ser Leu

	<b>U</b>	<b>C</b>	<b>A</b>	<b>G</b>	
<b>U</b>	Phe	Ser	Tyr	Cys	<b>U</b>
	Phe	Ser	Tyr	Cys	<b>C</b>
	Leu	Ser	*** ◀	*** ◀	<b>A</b>
	Leu	Ser	*** ◀	Trp	<b>G</b>
<b>C</b>	Leu	Pro	His	Arg	<b>U</b>
	Leu	Pro	His	Arg	<b>C</b>
	Leu	Pro	Gln	Arg	<b>A</b>
	Leu	Pro	Gln	Arg	<b>G</b>
<b>A</b>	Ile	Thr	Asn	Ser	<b>U</b>
	Ile	Thr	Asn	Ser	<b>C</b>
	Ile	Thr	Lys	Arg	<b>A</b>
	Met ▶	Thr	Lys	Arg	<b>G</b>
<b>G</b>	Val	Ala	Asp	Gly	<b>U</b>
	Val	Ala	Asp	Gly	<b>C</b>
	Val	Ala	Glu	Gly	<b>A</b>
	Val	Ala	Glu	Gly	<b>G</b>

# Structures of amino acids commonly found in proteins (20).

## Hydrophilic amino acids

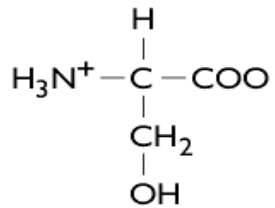

Serine (Ser) **S**

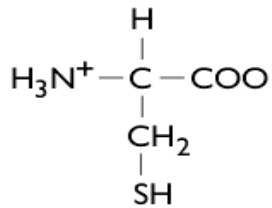

Cysteine (Cys) **C**

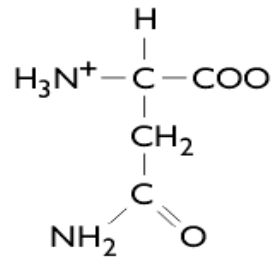

Asparagine (Asn) **N**

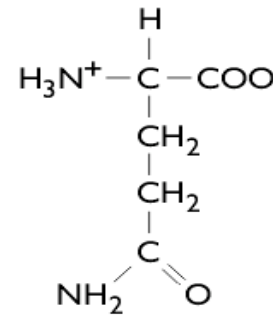

Glutamine (Gln) **Q**

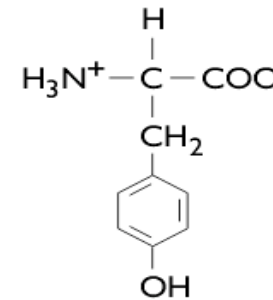

Tyrosine (Tyr) **Y**

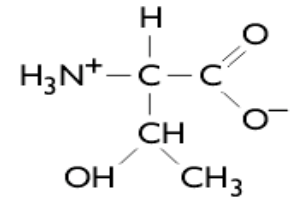

Threonine (Thr) **T**

## Polar

## Negatively charged

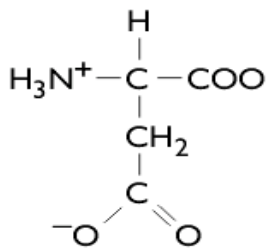

Aspartic acid (Asp) **D**

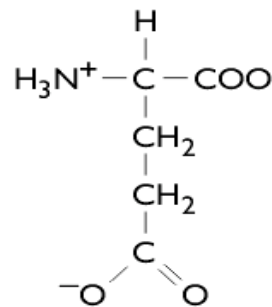

Glutamic acid (Glu) **E**

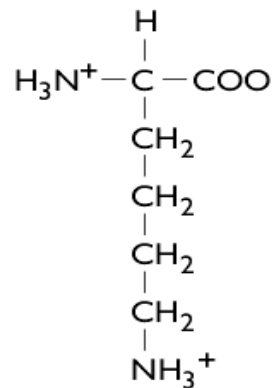

Lysine (Lys) **K**

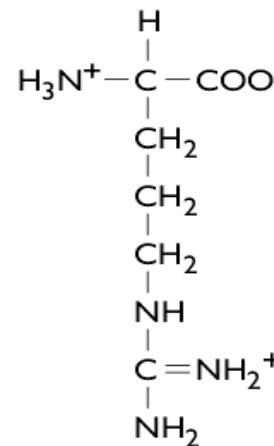

Arginine (Arg) **R**

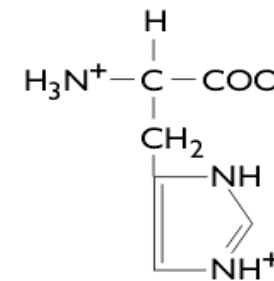

Histidine (His) **H**

## Positively charged

# Selenocysteine – the 21<sup>st</sup> amino acid

Selenocysteine appears in a number of oxidoreductase enzymes e. g. formate dehydrogenase, glycine reductase.

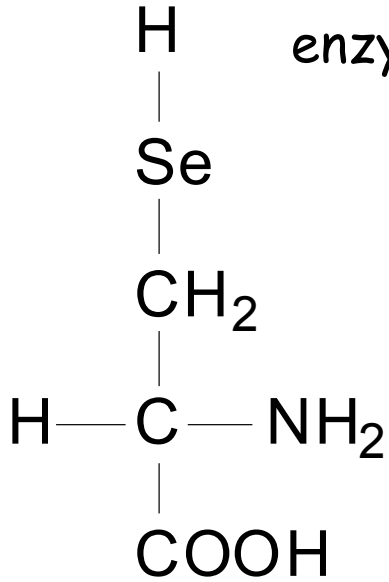

**UGA codon, normally nonsense !**  
(surrounding context allows to serve as 'sense' codon)

# Pyrrolysine – the 22<sup>nd</sup> amino acid

**UAG codon, normally nonsense !**

Pyrrolysine is found in enzymes involved in methanogenesis in a few bacteria and archaeobacteria.

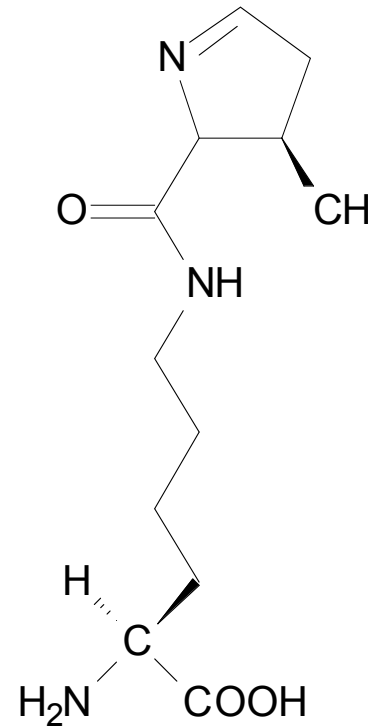



# Key components of translation

Messenger RNA

Transfer RNA

ribosomes and rRNA

Diagrams removed due to copyright restrictions.

See Figures 7-36 and 7-34 in Madigan, Michael, and John Martinko. *Brock Biology of Microorganisms*. 11th ed. Upper Saddle River, NJ: Pearson Prentice Hall, 2006. ISBN: 0131443291.

# Wobble base pairing

UUU	phenylalanine
UUC	

U-G and G-U base pairs are allowed in the 3rd position of the codon.

codon (mRNA)

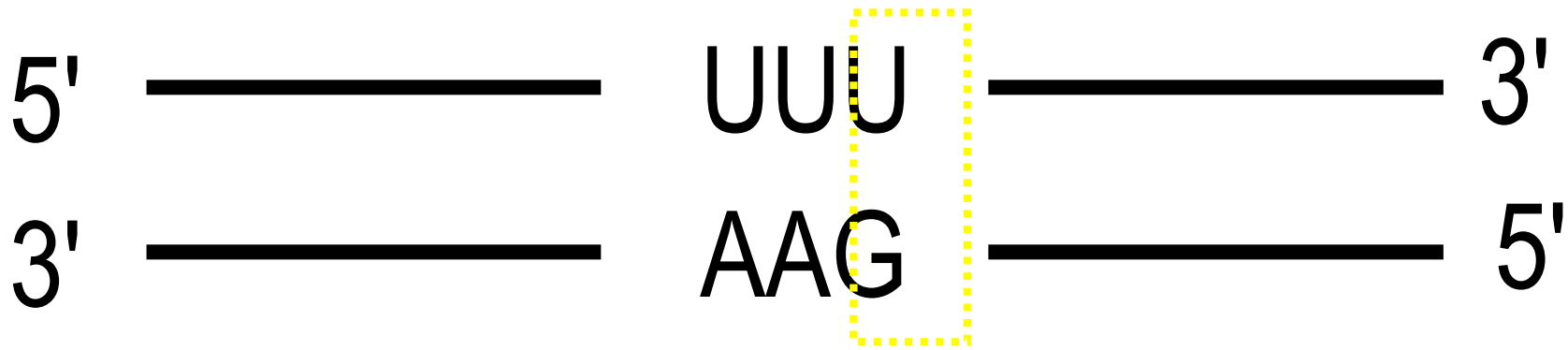

anticodon (tRNA)

# tRNA charging (adding amino acid)

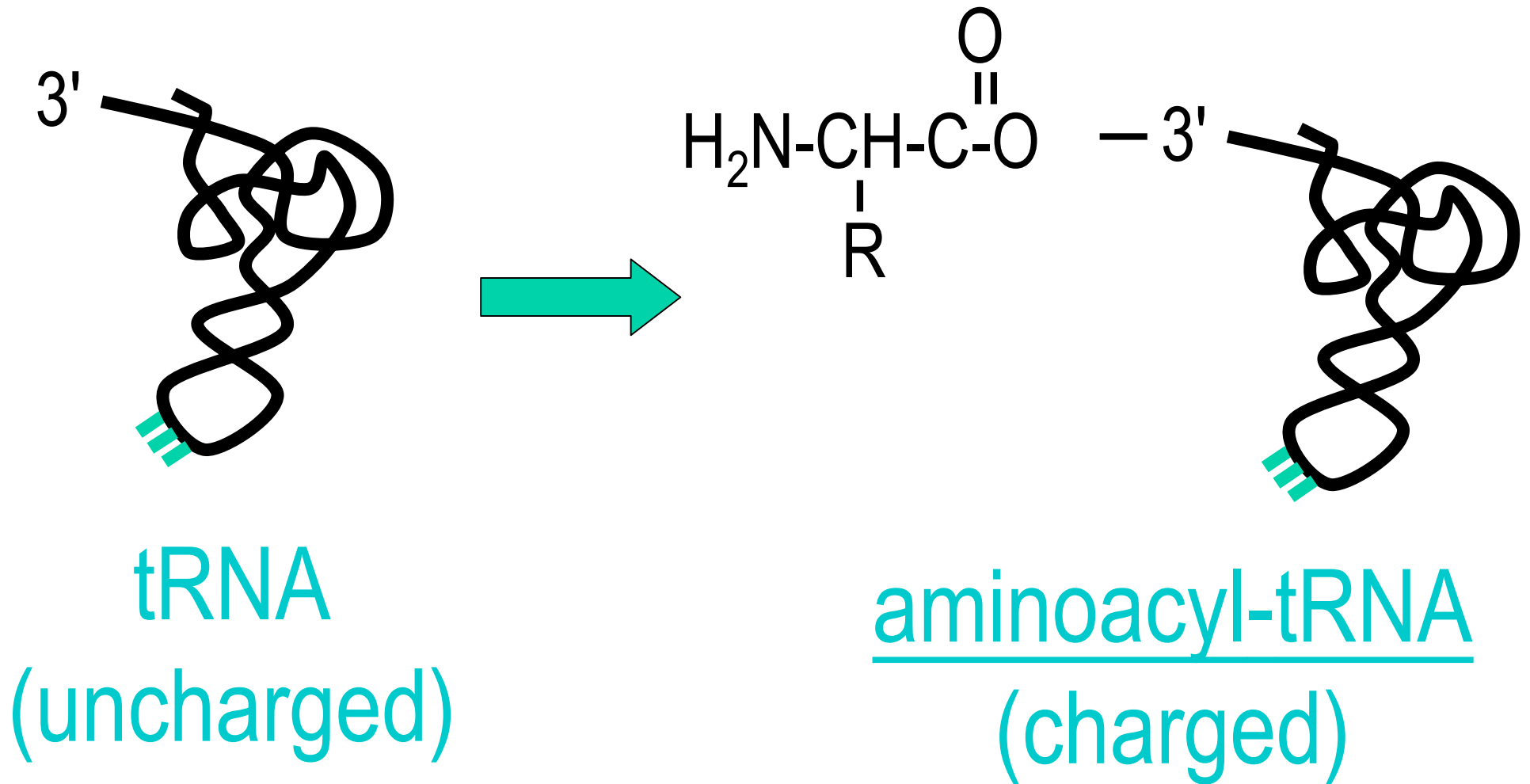

tRNA charging uses the energy of ATP

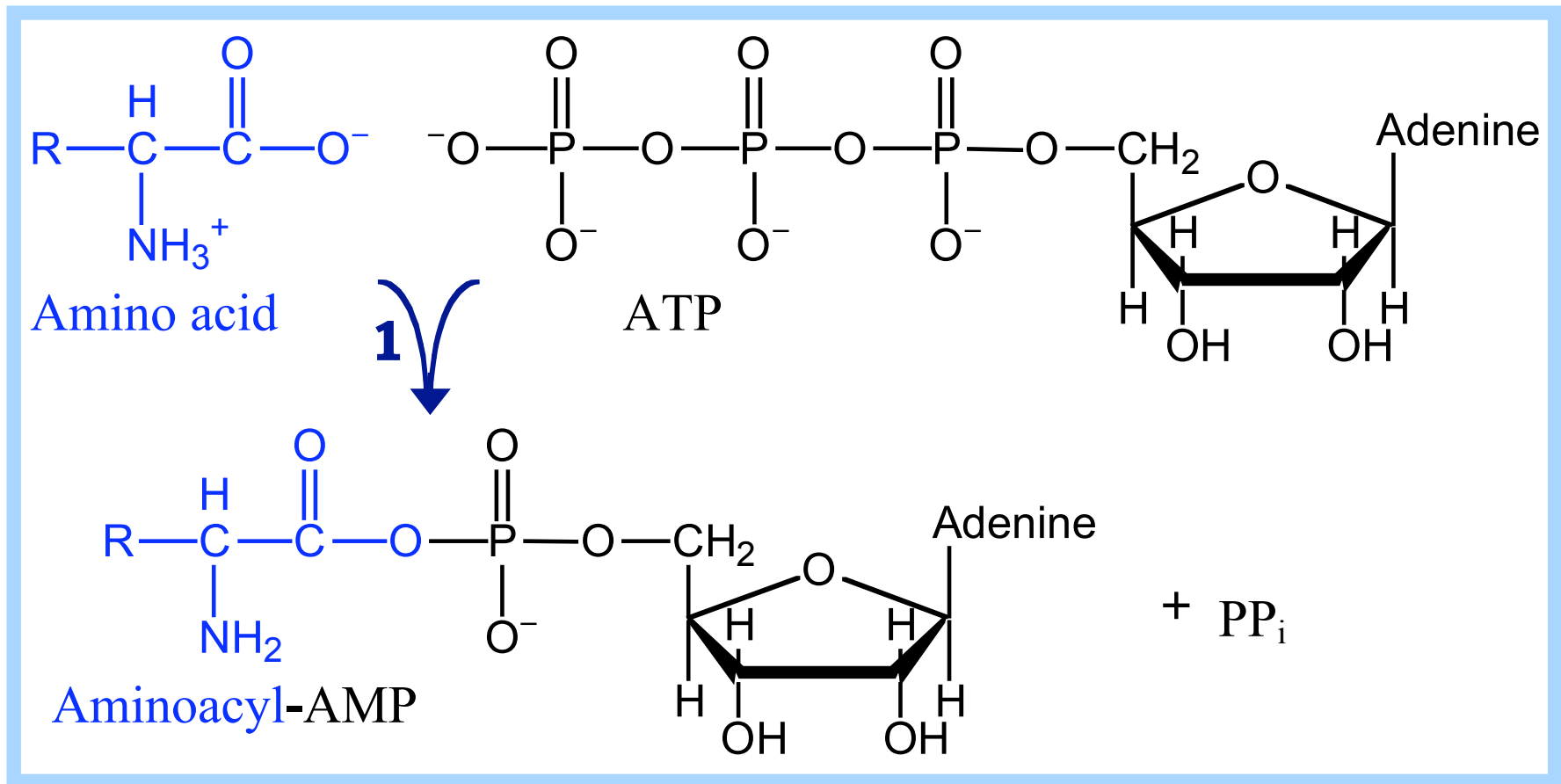

**Aminoacyl-tRNA Synthetases** catalyze linkage of the appropriate amino acid to each tRNA. The reaction occurs in two steps.

In **step 1**, an O atom of the amino acid  $\alpha$ -carboxyl attacks the P atom of the initial phosphate of ATP.

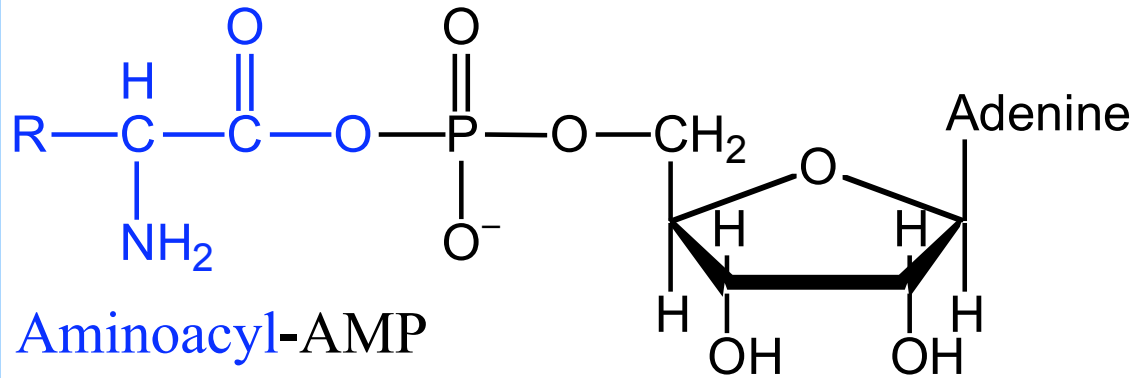

In **step 2**, the 2' or 3' OH of the terminal adenosine of tRNA attacks the amino acid carbonyl C atom.

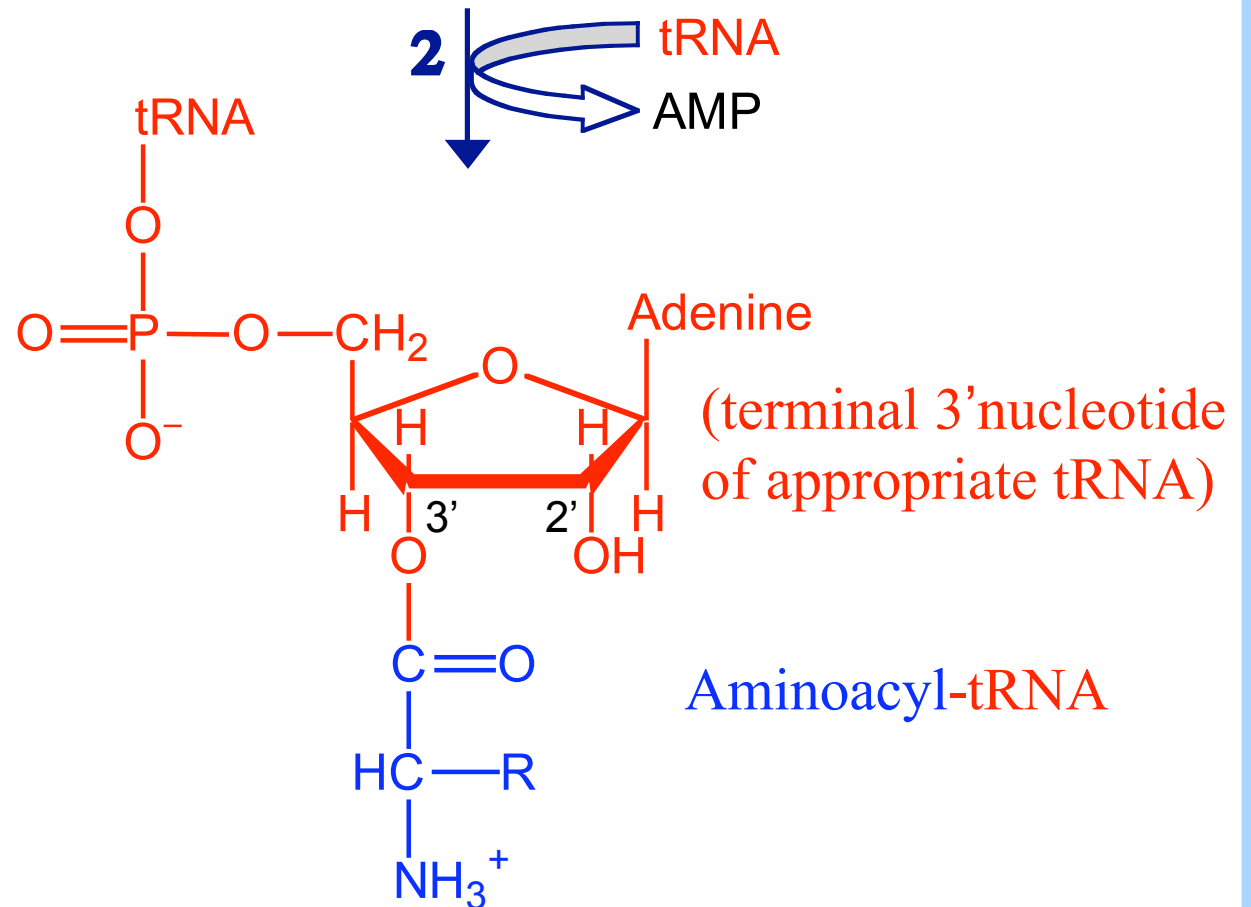

# Aminoacyl-tRNA Synthetase

---

Summary of the 2-step reaction:

1. **amino acid** + ATP  $\rightarrow$  **aminoacyl-AMP** + **PP<sub>i</sub>**
2. **aminoacyl-AMP** + **tRNA**  $\rightarrow$  **aminoacyl-tRNA** + **AMP**

The 2-step reaction is **spontaneous** overall, because the concentration of **PP<sub>i</sub>** is kept low by its hydrolysis, catalyzed by Pyrophosphatase.

There is a different **Aminoacyl-tRNA Synthetase (aaRS)** for each amino acid.

Each aaRS recognizes its particular amino acid and the tRNAs coding for that amino acid.

Accurate translation of the genetic code depends on attachment of each amino acid to an appropriate tRNA.

Domains of tRNA recognized by an aaRS are called **identity elements**.

Most identity elements are in the **acceptor stem & anticodon loop**.

Aminoacyl-tRNA Synthetases arose **early in evolution**. The earliest aaRSs probably recognized tRNAs only by their acceptor stems.

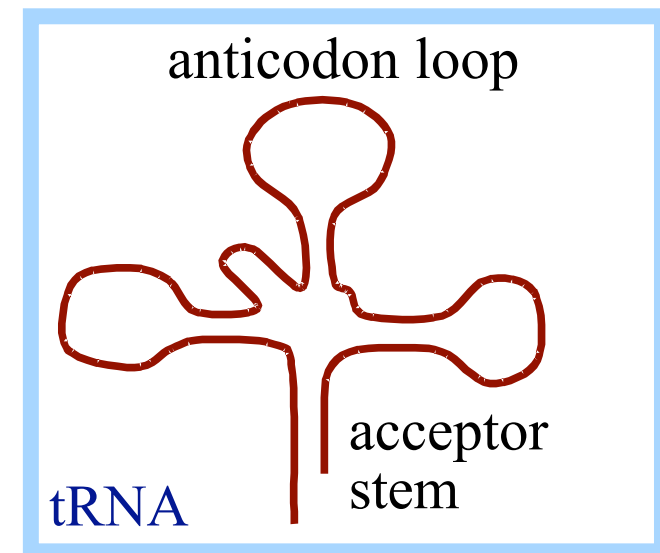



# Key components of translation

Messenger RNA

Transfer RNA

ribosomes and rRNA

# Structure of the *E. coli* Ribosome

Diagram of the structure of the *E. coli* ribosome removed due to copyright restrictions.

The cutaway view at right shows positions of tRNA (P, E sites) & mRNA (as orange beads).

Table of ribosome structure removed due to copyright restrictions.  
See Table 7-6 in Madigan, Michael, and John Martinko. *Brock Biology of Microorganisms*.  
11th ed. Upper Saddle River, NJ: Pearson Prentice Hall, 2006. ISBN: 0131443291.

# DRUGS THAT INHIBIT TRANSLATION

Inhibitor	Comments
<b>Chloramphenicol</b>	inhibits prokaryotic peptidyl transferase
<b>Streptomycin</b>	inhibits prokaryotic peptide chain initiation, also induces mRNA misreading
<b>Tetracycline</b>	inhibits prokaryotic aminoacyl-tRNA binding to the ribosome small subunit
<b>Neomycin</b>	similar in activity to streptomycin
<b>Erythromycin</b>	inhibits prokaryotic translocation through the ribosome large subunit
<b>Fusidic acid</b>	similar to erythromycin only by preventing EF-G from dissociating from large subunit
<b>Puromycin</b>	resembles an aminoacyl-tRNA, interferes with peptide transfer resulting in premature termination in both prokaryotes and eukaryotes
<hr/>	
<b>Diphtheria toxin</b>	catalyzes ADP-ribosylation of and inactivation of eEF-2
<b>Ricin</b>	found in castor beans, catalyzes cleavage of the eukaryotic large subunit rRNA
<b>Cycloheximide</b>	inhibits eukaryotic peptidyltransferase



BACTERIAL

EUKARYOTE

# Prokaryotic 70S ribosome

23s rRNA

5s rRNA

34 proteins

50s  
subunit

16s RNA

21 proteins

30s  
subunit

Secondary Structure: small subunit ribosomal RNA

Secondary Structure: small subunit ribosomal RNA  
Reference Sequence Numbering System

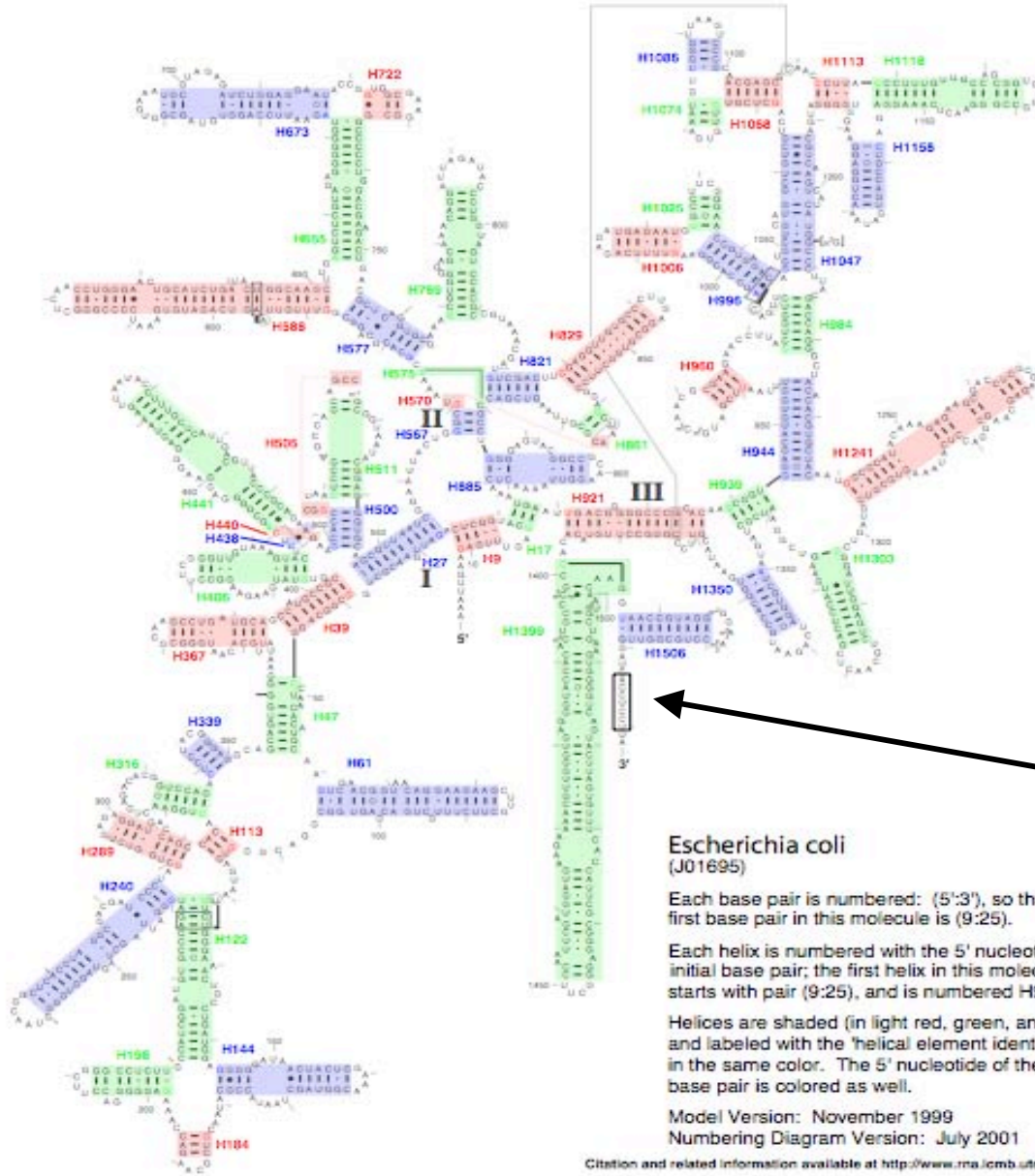

5' mRNA AGGAGGU 3'  
3' rRNA UCCUCCA 5'

Shine Delgamo seq.

Blue = Universal sites

Diagram removed due to copyright restrictions.

See Figure 7-38 in Madigan, Michael, and John Martinko. *Brock Biology of Microorganisms*. 11th ed. Upper Saddle River, NJ: Pearson Prentice Hall, 2006. ISBN: 0131443291.

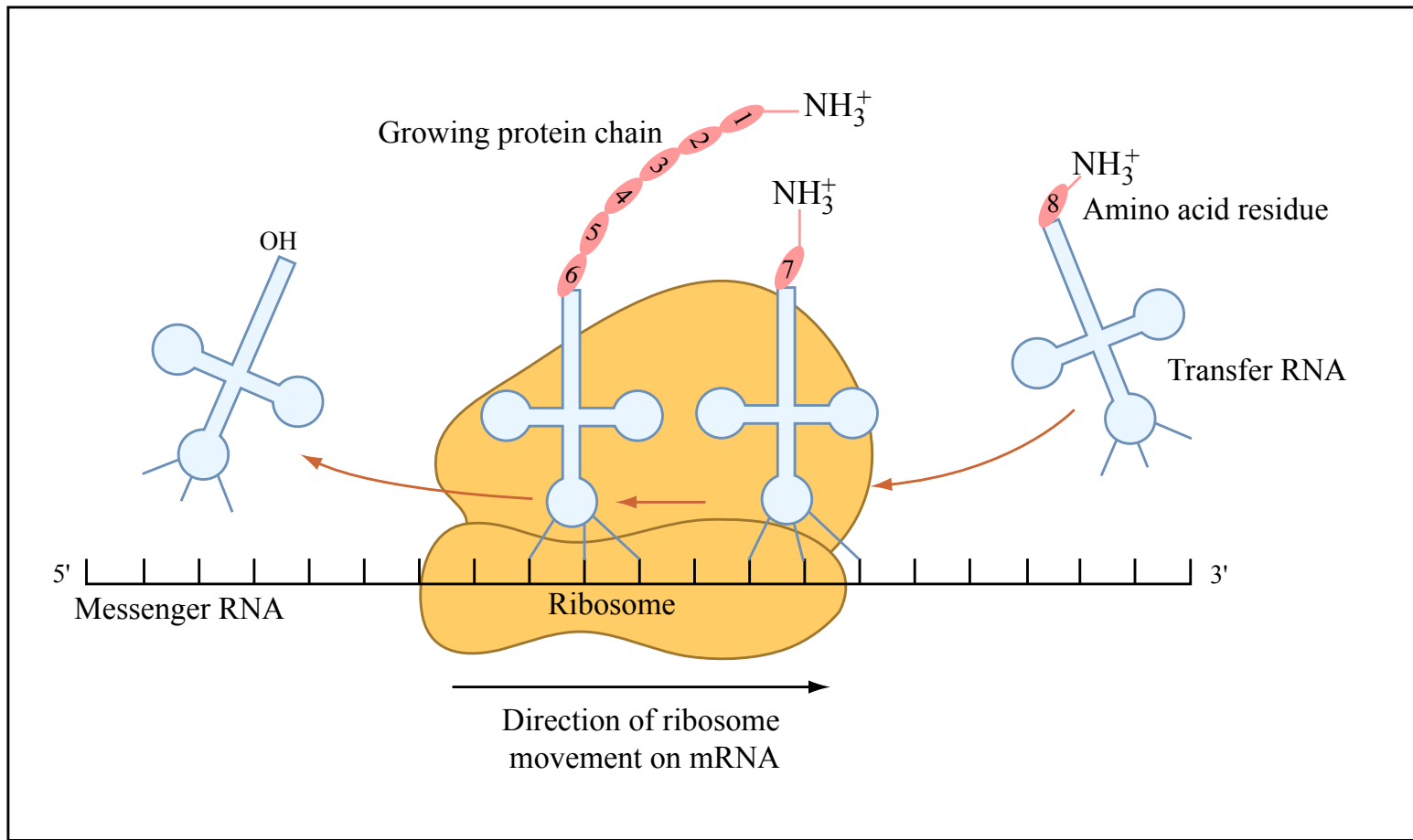

Figure by MIT OCW.



Diagram removed due to copyright restrictions.

See Figure 7-39 in Madigan, Michael, and John Martinko. *Brock Biology of Microorganisms*. 11th ed. Upper Saddle River, NJ: Pearson Prentice Hall, 2006. ISBN: 0131443291.

# RIBOZYMES ARE CATALYTIC RNAS

## EXAMPLES :

**Rnase P - (cleaves t-RNA presursor -> tRNA**

**Self splicing introns in eukaryotes**

**Ribosomes !!!!**

**The RNA Moiety of Ribonuclease P Is the Catalytic Subunit of the Enzyme**

**Cecilia Guerrier-Takada,\* Katheleen Gardiner,†  
Terry Marsh,† Norman Pace,† and Sidney Altman\***

\*Department of Biology  
Yale University

New Haven, Connecticut 06520

†Department of Molecular and Cellular Biology  
National Jewish Hospital and Research Center  
and Department of Biochemistry, Biophysics and  
Genetics

University of Colorado Medical Center  
Denver, Colorado 80206

**Disclaimer:** The above contents have been collected/ compiled from different sources of internet and may be protected under copyright. If anyone publish/ copy/ transmit with an intention to publish with some modifications in his/her name, then all the liability/ legal offences will be bear by such individual/ individual/ organization/ organization/ entity who have misused the content.

**Shailendra Sharma**